

DS33R11DK/DS33ZH11DK Ethernet Transport Design Kit

www.maxim-ic.com

GENERAL DESCRIPTION

The DS33R11/DS33ZH11 design kit is an easy-to-use evaluation board for the DS33R11 and the DS33ZH11 Ethernet transport-over-serial link devices. The DS33ZH11 section of the design kit contains an option for either T3E3 or T1E1 serial links. The DS33R11 chipset has an integrated T1E1 transceiver. All serial links are complete with line interface, transformers, and network connections. Dallas' ChipView software is provided with the design kit, giving point-and-click access to configuration and status registers from a Windows®-based PC. On-board LEDs indicate receive loss-of-signal, queue overflow, Ethernet link, Tx/Rx, and interrupt status.

Windows is a registered trademark of Microsoft Corp.

DESIGN KIT CONTENTS

DS33R11DK/DS33ZH11DK Main Board (DS33R11 + DS33ZH11)

CD ROM:

- ChipView Software and Manual
- DS33R11DK/DS33ZH11DK Data Sheet
- Configuration Files

FEATURES

- Demonstrates Key Functions of DS33R11 and DS33ZH11 Ethernet Transport Chipsets
- DS33ZH11 Section Includes DS21348 T1E1 LIU and DS3150 T3E3 LIU, Transformers, BNC and RJ48 Network Connectors and Termination
- Provides Support for Hardware and Software Modes
- On-Board MMC2107 Processor and ChipView Software Provide Point-and-Click Access to DS33R11 Register Set
- All DS33R11 and DS33ZH11 Interface Pins are Easily Accessible for External Data Source/Sink
- LEDs for Loss-of-Signal, Queue Overflow, Ethernet Link, Tx/Rx, and Interrupt Status
- Easy-to-Read Silkscreen Labels Identify the Signals Associated with All Connectors, Jumpers, and LEDs

ORDERING INFORMATION

PART	DESCRIPTION
DS33R11DK	Design Kit for DS33R11 and DS33ZH11

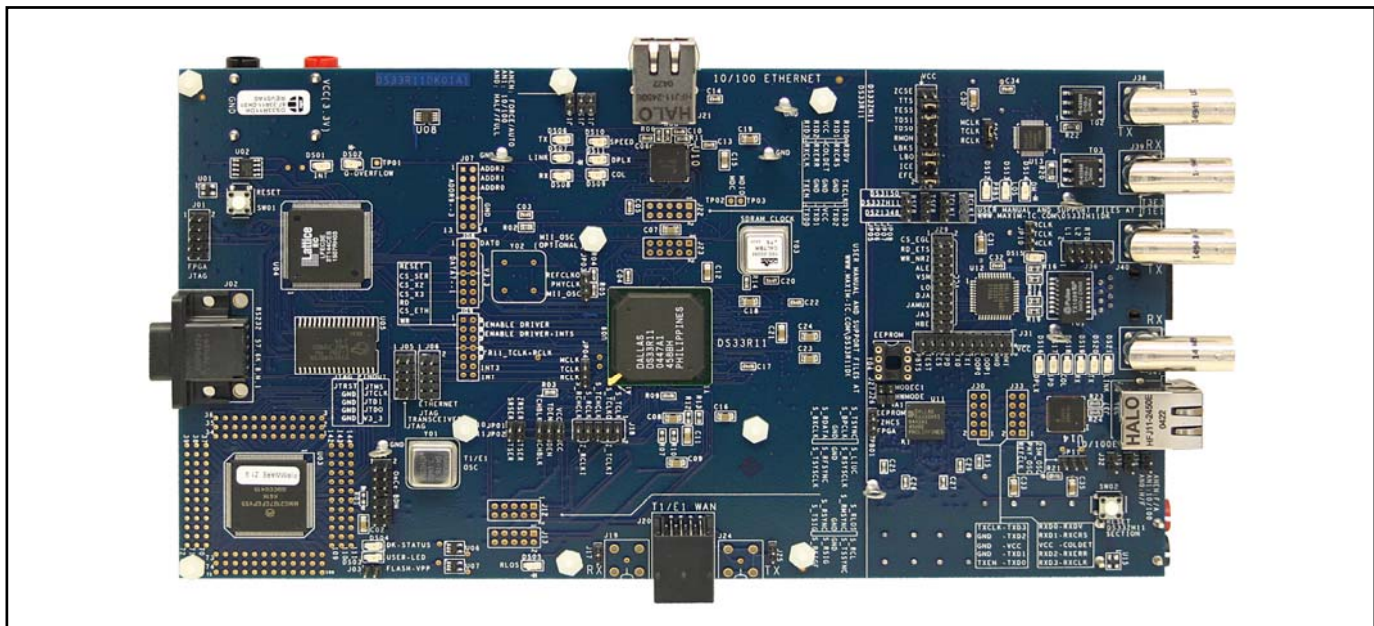

TABLE OF CONTENTS

GENERAL DESCRIPTION	1
DESIGN KIT CONTENTS	1
ORDERING INFORMATION	1
COMPONENT LIST	3
SYSTEM FLOORPLAN	8
PC BOARD ERRATA	8
FILE LOCATIONS	9
BASIC OPERATION.....	10
POWERING UP THE DESIGN KIT	10
<i>General</i>	10
BASIC DS33R11 INITIALIZATION	10
<i>Additional Configuration for DS33R11</i>	10
BASIC DS33ZH11 INITIALIZATION.....	11
<i>Additional Configuration for DS33ZH11</i>	11
MONITOR AND CAPTURE ETHERNET TRAFFIC	11
LEDS, CONFIGURATION SWITCHES, JUMPERS, AND CONNECTORS	12
ADDRESS MAP (ALL CARDS)	16
DS33R11 INFORMATION	16
DS33R11DK/DS33ZH11DK INFORMATION	17
TECHNICAL SUPPORT	17
SCHEMATICS	17

COMPONENT LIST

DESIGNATION	QTY	DESCRIPTION	SUPPLIER/PART NUMBER
C01, C28, CB03, CB49, CB136, CB146, CB192, CP01, CP2, CP03	10	470 μ F \pm 20%, 6.3V tantalum capacitors (D case)	KEM T491D477M006AS
C02, C11, C30, CB36, CB37, CB40–CB43, CB45, CB153, CB195, CB197	13	1 μ F \pm 10%, 16V ceramic capacitors (1206)	Panasonic ECJ-3YB1C105K
C03–C06, C13, C14, C17, C20, C22, C26, C29, . . .incomplete listing (94 devices total)	94	0.1 μ F \pm 10%, 16V ceramic capacitors (0603)	Phycomp 06032R104K7B20D
C07, C08, C09, C12, C16, C18, C19, C21, C23, C24, C31, . . . incomplete listing (81 devices total)	81	10 μ F \pm 20%, 10V ceramic capacitors (1206)	Panasonic ECJ-3YB1A106M
C10, CB23, CB24, CB26, CB33, CB91, CB95, CB151, CB161, CB162, CB175, CB177, CB181, CB185, CB189, CB190	16	0.1 μ F \pm 20%, 16V X7R ceramic capacitors (0603)	AVX 0603YC104MAT
C15, CB76, CB77, CB169, CB179, CB188	6	10 μ F \pm 20%, 10V ceramic capacitors (1206)	Panasonic ECJ-3YB1A106M
C25, C27, CB154–CB156, CB158–CB160, CB166, CB173, CB174, CB182, CB183	13	4.7 μ F, 6.3V ceramic multilayer capacitors (0603)	UNK ECJ-1VB0J475M
CB105	1	0.1 μ F \pm 10%, 16V ceramic capacitor (0805)	Phycomp 08052R104K7B20D
CB180	1	1 μ F \pm 10%, 16V ceramic capacitor (1206)	Panasonic ECJ-3YB1C105K
DB01	1	1A, 40V Schottky diode	International Rectifier 10BQ040
DS01, DS02, DS05, DS13, DS14	5	Red LEDs (SMD)	Panasonic LN1251C
DS03, DS08, DS15, DS19	4	Red LEDs (SMD)	Panasonic LN1251C
DS04, DS07, DS12, DS21	4	Green LEDs (SMD)	Panasonic LN1351C
DS06, DS09, DS10, DS11, DS16, D17, DS18, DS20	8	Amber LEDs (SMD)	Panasonic LN1451C
GND_TP01, GND_TP02, GND_TP03, GND_TPB01, GND_TPP01–GND_TPP23	27	Standard ground clip	Keystone 4954
H01–H06, HB01, HB02, HB03	9	Kit, 4-40 hardware, 0.5" nylon standoff and nylon hex-nut	Lab stock 4-40KIT6

DESIGNATION	QTY	DESCRIPTION	SUPPLIER/PART NUMBER
J01, J05, J06, J18, J36	5	Terminal strip (10-pin, dual row, vertical)	Samtec TSW-105-07-T-D
J02	1	DB9 right-angle connector (long case)	AMP 747459-1
J03, J10, J11, J14–J17, J25, J26, J27, J32, J34, J35	13	100-mil, 2-position jumpers	Lab stock Not applicable
J04	1	100-mil, 2 x 7-position jumper	Lab stock Not applicable
J07, J08, J09	3	Not Populated 14-pin headers, dual row, vertical	Samtec NOPOP-HDR-TSW-107-14-T-D
J12, J13, J22, J23, J30, J33	6	L_TERMINAL STRIP, 10 PIN, DUAL ROW, VERT DO NOT POPLUATE	DNP
J19, J24	2	Not Populated 5-pin connectors, BNC 75Ω, right angle	Trompetor NOPOP-UCBJR220
J20, JB03	2	8-pin single-port RJ48 connectors	MOLEX 15-43-8588
J21, J37	2	8-pin connectors (fastjack single, for national PHY)	Halo Electronics HFJ11-2450E
J28, J29, J31	3	20-pin headers (dual row, vertical)	Samtec HDR-TSW-110-14-T-D
J38, J39	2	5-pin BNC connectors (75Ω, right angle)	Trompetor UCBJR220
J40, J41	2	5-pin BNC connectors (right angle)	Trompetor UCBJR220
JB01, JB05	2	Sockets, banana plug, horizontal, black	Mouser Electronics 164-6218
JB02, JB04	2	Sockets, banana plug, horizontal, red	Mouser Electronics 164-6219
JP01–JP11, JPB01	12	100-mil, 3-position jumpers	Lab stock Not applicable
R1, R2	2	1.0kΩ ±5%, 1/16W resistors (0603)	Panasonic ERJ-3GEYJ103V
R01	1	1.0MΩ ±5%, 1/16W resistor (0603)	Panasonic ERJ-3GEYJ105V
R02	1	10kΩ ±1%, 1/10W resistor (0805)	Panasonic ERJ-6ENF1002V
R03, R04, R05, R09, R14, R15, R21, RB35, RB52, RB53, RB58, RB69, RB70, RB73, RB77–RB86, RB89, RB90, RB93–RB96, RB101, RB132, RB133, RB137, RB138, RB144, RB151–RB155, RB159, RB162	43	30Ω, 1/16W resistors (0603)	Panasonic ERJ-3GEYJ300V
R06, R08, R23, R24	4	49.9Ω ±1%, 1/16W resistors (0603)	Panasonic ERJ-3EKF49R9V

DESIGNATION	QTY	DESCRIPTION	SUPPLIER/PART NUMBER
R07, R10, R12, R13, RB15	5	0Ω ±5%, 1/16W resistors (0603)	Panasonic ERJ-3GEY0R00V
R11, RB167	2	10.0kΩ ±1%, 1/16W resistors (0603)	Panasonic ERJ-3EKF1002V
R16–R19	4	0Ω ±5%, 1/10W resistors (0805)	Panasonic ERJ-6GEY0R00V
R20, R22	2	330Ω ±5%, 1/8W resistors (1206)	Panasonic ERJ-8ENF3300V
RB01–RB03, RB06–RB13, RB17, RB18, RB22, RB25, RB27, RB28, RB32, RB33	19	10kΩ ±5%, 1/16W resistors (0603)	Panasonic ERJ-3GEYJ103V
RB04, RB05, RB30, RB31, RB34, RB36–RB43, RB59–RB61, RB63, RB99, RB100, RB150	20	10kΩ ±5%, 1/16W resistors (0603)	Panasonic ERJ-3GEYJ103V
RB129	1	30Ω ±5%, 1/16W resistor (0603)	Panasonic ERJ-3GEYJ300V
RB14, RB19, RB44–RB47, RB49–RB51, RB54, RB97, RB98, RB102, RB104, RB116, RB178	16	2.0kΩ ±5%, 1/16W resistors (0603)	Panasonic ERJ-3GEYJ202V
RB148, RB149	2	61.9Ω ±1%, 1/10W resistors (0805)	Panasonic ERJ-6ENF61R9V
RB156	1	330Ω ±5%, 1/10W resistor (0805)	Panasonic ERJ-6GEYJ331V
RB16, RB20, RB48, RB66, RB67, RB68, RB71, RB74, RB75, RB135, RB142, RB146, RB157, RB161, RB165, RB169, RB174, RB176	18	330Ω ±5%, 1/16W resistors (0603)	Panasonic ERJ-3GEYJ331V
RB177	1	51.1Ω ±1%, 1/10W resistor (0805)	Panasonic ERJ-6ENF51R1V
RB21, RB23	2	330Ω ±5%, 1/16W resistors (0603)	Panasonic ERJ-3GEYJ331V
RB24	1	1.0kΩ ±5%, 1/16W resistor (0603)	Panasonic ERJ-3GEYJ102V
RB26, RB103, RB105–RB115, RB117–RB128, RB130, RB131, RB134, RB136, RB139–RB141, RB143, RB163, RB166, RB170	36	1.0kΩ ±5%, 1/16W resistors (0603)	Panasonic ERJ-3GEYJ102V
RB29	1	0Ω ±5%, 1/8W resistor (1206)	Panasonic ERJ-8GEYJ0R00V

DESIGNATION	QTY	DESCRIPTION	SUPPLIER/PART NUMBER
RB55, RB56, RB57, RB62, RB64, RB65, RB72, RB76, RB145, RB147, RB158, RB160, RB164, RB168, RB173, RB175	16	5.1k Ω \pm 5%, 1/16W resistors (0603)	Panasonic ERJ-3GEYJ512V
RB87, RB91	2	60.4 Ω \pm 1%, 1/10W resistors (0805)	Panasonic ERJ-6ENF60R4V
RB88, RB92, RB171, RB172	4	54.9 Ω \pm 1%, 1/16W resistors (0603)	Panasonic ERJ-3EKF54R9V
SHORT01	1	2-position SMD jumper Do not populate. Intended to have solder bridge during assembly.	Not populated
SW01, SW02	2	4-pin single-pole switch	Panasonic EVQPAE04M
T01	1	16-pin dual SMT transformer	Pulse Engineering TX1099
T02, T03	2	6-pin SMT transformers (1:2CT, transmitter/receiver)	Pulse Engineering PE-65968
TB01	1	12-pin SMT transformer (1CT:1CT and 1CT:2CT)	Pulse Engineering PE-68877
TP01-TP03, TPB01- TPB11, TPP01, TPP02	16	Test points (one plated hole) Do not stuff.	—
U01, U15	2	Microprocessor voltage monitors 2.93V reset, 4-pin SOT143	Maxim MAX811SEUS-T
U02	1	2Mb SPI serial EEPROM 8-pin SO, 2.7V to 3.6V	Atmel AT25F2048N-10SU-2.7
U03	1	MMC2107 Processor	Motorola MMC2107
U04	1	FPGA IC 1.2V, 20mm x 20mm, 144-pin TQFP	Lattice Semiconductor LFEC3E-3T144C
U05, UB03	2	Cypress SRAM, Lab Stock	Lab stock
U06, U07	2	High-speed inverters	Fairchild Semiconductor NC7SZ86
U08, UB07	2	1.8V or Adj 8-Pin μ MAX/SO	Maxim MAX1792EUA18
U09	1	DS33R11, Z44/2156 MCM 27mm x 27mm, 256-pin BGA	Dallas Semiconductor DS33R11
U10, U14	2	DsPHYTER II Single 10/100 Ethernet transceiver (65-pin LLP)	National Semiconductor DP83847ALQA56A

DESIGNATION	QTY	DESCRIPTION	SUPPLIER/PART NUMBER
U11	1	DS33ZH11 ELITE 10/100 Ethernet transport over serial link 10mm x 10mm, 100-pin CSBGA	Dallas Semiconductor DS33ZH11
U12	1	DS21348 LIU 44-pin TQFP	Dallas Semiconductor DS21348
U13	1	DS3150 T3/E3/STS-1 LIU I/F 48-pin TQFP	Dallas Semiconductor DS3150T
UB01	1	Dual RS-232 transceiver with 3.3V/5V internal capacitors	Maxim MAX3233E
UB02	1	LDO regulator with reset, 1.20V output 300mA, 6-pin SOT23	Maxim MAX1963EZT120-T
UB04, UB05	2	Synchronous DRAM, 1Meg x 32 x 4 banks, 86-pin TSOP	Micron MT48LC4M32B2TG-7
UB06	1	High-speed buffer	Fairchild Semiconductor NC7SZ86
XB01	1	Low-profile 8.0MHz crystal	ECL EC1-8.000M
Y01, YB05	2	Oscillator, crystal clock 3.3V, 2.048MHz (needs socket)	SaRonix NTH039A3-2.0480
Y02	1	Not populated Oscillator, crystal clock 3.3V, 25.000MHz (low jitter)	SaRonix NTH089AA3-25.000
Y03, YB03	2	Oscillator, crystal clock 3.3V, 100.000MHz	SaRonix NTH089A3-100.0000
Y04	1	SPI serial EEPROM 2.7V, 16k, 8-pin DIP (needs socket)	Atmel AT25160A-10PI-2.7
Y05	1	Oscillator, crystal clock, 3.3V, 34.368MHz (needs socket)	SaRonix NTH089AA3-34.368
YB01	1	Oscillator, crystal clock 3.3V, 44.736MHz (needs socket)	SaRonix NTH089AA3-44.736
YB02	1	Oscillator, crystal clock 3.3V, 1.544MHz (needs socket)	SaRonix NTH039A3-1.5440
YB04	1	Oscillator, crystal clock 3.3V, 25.000MHz (low jitter)	SaRonix NTH089AA3-25.000

SYSTEM FLOORPLAN

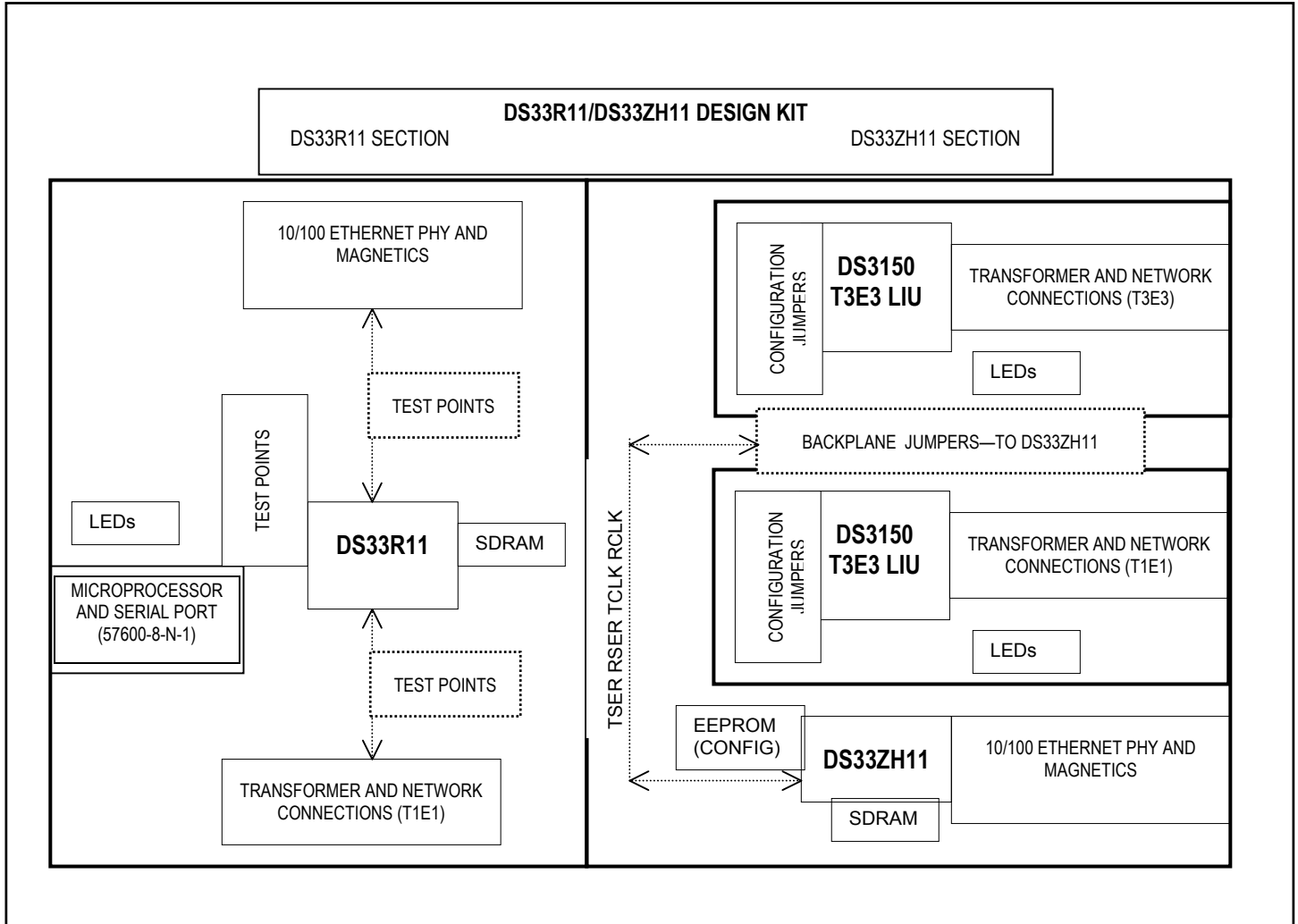

PC BOARD ERRATA

- Center tap of T02 was not pulled to V3_3 in DS33R11DK/DS33ZH11DK01A0 revision (page 23 in schematic). Pin T02.2 is pulled to V3_3 with a wire in the DS33R11DK/DS33ZH11DK01A0 revision.
- Reference designators were assigned for R1, R2 and R01, R02. R1 and R2 will be renamed in the next design.
- Component R1, R2 and Y05 are on bottom of the PC board but do not have the same prefix as other components on the bottom side.
- Silkscreen for J36.6 is mislabeled. It reads "RT0" but should read "RT1."
- Oscillators Y03 and YB03 are not suitable for use as input clocks for the Ethernet PHY. Because of this, the oscillators will only be used as the SDRAM oscillators. These oscillators generate too much jitter to function as the input clock for the PHY. This requires that the PHY is driven by the default oscillator, YB04 and YB02. Jumpers JP03 and JP11 have been modified to prevent accidental selection of the wrong oscillator.

FILE LOCATIONS

This design kit relies upon several supporting files, which are provided on the CD and are available as a zip file from the Maxim website at www.maxim-ic.com/DS33R11DK.

All locations are given relative to the top directory of the CD/zip file.

Table 1. DS33Z11 Register Definition and Configuration Files

FILE NAME.	FILE USAGE
.\DS33R11_cfg_demo_gui\DS33Z11.def	Top level definition file to select in ChipView's register mode. This file autoloads the remaining definition files shown below. (Note: The DS33R11 is composed of an integrated DS33Z11 and an integrated DS2155.)
.\DS33R11_cfg_demo_gui\SU_LI_PORT1.def .\DS33R11_cfg_demo_gui\DS2155.def	Dependant files. These are called by the DS33Z11.def file, which is listed above.
.\DS33R11_cfg_demo_gui\basic_Config.eset	GUI interface for loading settings when running the Zchip plug-in (launched from the Tools menu of the ChipView program).
.\DS33R11_cfg_demo_gui\basic_config.mfg .\DS33R11_cfg_demo_gui\e1_gapclk_crc4_hdb3_nocas.ini	Files for manually configuring the DS33Z11 and DS2155 to convert Ethernet traffic to serial a T1E1 stream.
.\DS33R11_cfg_demo_gui\DS2155_T1_BERT_ESF.ini .\DS33R11_cfg_demo_gui\gapclk_llb_DS2155_T1_ESF_LBO0_2.ini	Stand-alone configuration files for evaluating the DS33R11's integrated DS2155 T1E1 transceiver. These files are for evaluating DS2155 functionality, and disrupt the Ethernet to serial traffic flow.

BASIC OPERATION

Powering Up the Design Kit

- Connect PCB 3.3V and GND banana plugs to power supply. A 2A supply is recommended. At steady-state, the system should draw approximately 700mA.
- Verify that jumpers are configured as described in [Table 2](#).

General

- Upon power-up, the DS33R11 Queue overflow LED (DS02 red) will not be lit; also, the INT LED (DS01 red) will not be lit. PHY LINK LED (DS07 green) should be lit if the Ethernet is connected. Transceiver RLOS LED (DS05 red) will be lit.
- DS33ZH11 does not have Queue overflow or INT pins. DS21348 and DS3150 RLOS LEDs (DS15 and DS13 red) will be lit.

Following are several basic system initializations.

Basic DS33R11 Initialization

This section covers two basic methods for configuring the DS33R11.

1. Device-Driver Based Configuration. If the pins J09.4+J09.6 are jumpered, the device driver autoconfigures the DS33R11 upon power-up. This enables traffic to pass from the Ethernet port to the serial port. Consult the device driver documentation for further details.
2. Register-Based Configuration. Launch *ChipView.exe* and select *Register View*. When prompted for a definition file, pick the file named **DS33Z11.def**. Three definition files will load: DS33Z11 control, DS33Z11 port, and DS2155 transceiver. Go to the File menu and select *File*→*Memory Config File*→*Load* .MFG file. When prompted, select the file named **basic_config.mfg**. Following this, load the file **e1_gapclk_crc4_hdb3_nocas.ini** using the menu selection *File*→*Initialization Config File*→*Load* .INI file.

Additional Configuration for DS33R11

- Using a patch cable, connect the Ethernet connector to an ordinary PC, or network test equipment. This should cause the link LED to turn on.
- Place a loopback connector at the T1E1 network side; RLOS LED DS05 should go out.
- At this point any packets sent to the DS33R11 are echoed back. Incoming packets (i.e., ping) should cause the RX LED to blink, after which the TX LED should also blink.

Basic DS33ZH11 Initialization

This section covers the EEPROM methods for configuring the DS33ZH11.

- 1) If the HWMODE jumper is installed, the DS33ZH11 will retrieve configuration settings from the on-board EEPROM during power-up.
- 2) Select which serial device to use: either the DS3150 T3E3 LIU or the DS21348 T1E1 LIU can be selected. In making this selection the backplane jumpers JP05–JP08 must be installed to select between the two serial devices. Connecting pins 2+3 of each jumper selects the DS3150, connecting pins 1+2 of each jumper selects the DS21348.
- 3) Configure the serial device as shown in [Table 2](#).

Additional Configuration for DS33ZH11

- Using a patch cable, connect the Ethernet connector to an ordinary PC, or network test equipment. This should cause the link LED to turn on.
- Place a loopback connector at the network side; the RLOS LED should go out. The RLOS LED is DS15 for T1E1 and DS13 for T3E3.
- At this point any packets sent to the DS33ZH11 are echoed back. Incoming packets (i.e., ping) should cause the RX LED to blink, after which the TX LED should also blink.

Monitor and Capture Ethernet Traffic

- Although ping is mentioned, it is **not** recommended. The ping command goes through the computer's TCP/IP stack, and sometimes is not sent out the PC's network connector (i.e., if the PC's ARP cache is out of date). Additionally, ping requires two PCs, as a PC with only one adapter cannot ping itself (a local ping gets sent to a local host instead of out the connector). However, note that ping is still a valuable test once the prototyping stage is complete.
- Generation and capture of arbitrary (raw) packets can be accomplished using CommView. A time-limited demo is available at the website www.tamos.com/products/commview.
- Ethereal is an excellent (and free) packet capture utility. Download at www.ethereal.com.
- Adding additional Ethernet ports to a PC is rather simple when a USB-to-Ethernet adapter is used. This allows for end-to-end testing using a single PC. When using two adapters, the PC has a different IP address for each adapter. Test equipment allows selection of either adapter. Operating system-based network traffic is sent out the default adapter. Typically, this is the adapter that has recently had connection to a live network.

LEDS, CONFIGURATION SWITCHES, JUMPERS, AND CONNECTORS

The DS33Z11DK has several configuration switches, banana plugs, oscillators, and jumpers. [Table 2](#) provides a description of these signals, given in order of appearance on the PC board, from top to bottom then left to right (with the board held so that the RS232 connector is on the left edge).

Table 2. Main Board PC Board Configuration

SILKSCREEN REFERENCE	FUNCTION	BASIC SETTING	SCHEMATIC PAGE	DESCRIPTION
GROUND (banana plug)	Power supply ground	—	2	System power. Always connected to power supply. Connectors are provided at the top left and bottom right of board. Connect either set to power supply.
VDD 3.3V (banana plug)	Power supply VDD	—	2	
J01	JTAG	—	17	JTAG interface for Lattice EC3 FPGA.
J02	RS-232 DB9 connector	—	14	RS-232 DB9 connector, operates in ASCII mode at 57.6K baud, 8, N, 1.
SW01	Reset		12	Drives reset controller U01.
DS01	LED	—	15	Displays interrupt status of DS33R11 (lit when interrupt is asserted).
DS02	LED		7	Displays Queue overflow status of DS33R11 (lit when Queue overflows).
J04	OnCe BDM	—	14	Debug connector for processor.
J03	Flash VPP	3.3V	14	Jumper for driving MMC2107 flash VPP to 5V .
J05	JTAG	—	10	JTAG interface for DS2155 portion of DS33R11.
J06	JTAG	—	11	JTAG interface for DS33Z11 portion of DS33R11.
Y01	Clock	—	11	Oscillator for DS2155 portion of the DS33R11.
J07, J08	Addr / Dat	—	16	Address and Databus Test points for DS33R11.
J09	Configuration pins (See next two rows for details.)	Schematic Page16	Configuration switches for selecting device driver behavior. Additional detail given below.	
J09.2+J09.4	Removed	Not installed	Pin J09.2 has been removed. Jumpering this pin to J09.4 causes a conflict with J09.6 FPGA pin.	
J09.4+J09.6	Driver Enable	Installed	Enables device driver and interrupt handler when jumper is installed.	
J09.8+J09.10	RCLK select (FPGA)	User selection	Causes device to select serial link TCLK = RCLK when jumpered. When not jumpered TCLK = MCLK.	
Y02	Ethernet PHY Clock	—	3	25.000MHz clock for DS33R11 Ethernet PHY.
JP03	Clock select	Pins 1+2 Jumpered	3	Must be set with pins 1+2 jumpered. SDRAM oscillator does not meet jitter requirement of the Ethernet PHY.
J10	Jumper	Installed	10	Connects DS33R11 receive serial lines.
J11	Jumper	Installed	10	Connects DS33R11 transmit serial lines.

SILKSCREEN REFERENCE	FUNCTION	BASIC SETTING	SCHEMATIC PAGE	DESCRIPTION
JP01	3-pin jumper	Pins 2+3 jumpered	10	Drives DS33R11 TDEN pin to VCC.
JP02	3-pin jumper	Pins 2+3 jumpered	10	Drives DS33R11 RDEN pin to VCC.
J18	Test points	Pins 9+10 and 5+6 jumpered	10	Test points, connecting RCLK and TCLK to channel clock pins of transceiver.
J12, J13	Test points	—	11	Test points for integrated transceiver of DS33R11.
J14, J15, J16	Jumpers	Not installed	4	Installation forces Ethernet PHY mode. When not installed the PHY autonegotiates its settings.
DS06, DS07, DS08	LED	—	4	Activity LEDs for Ethernet PHY. Tx lights when PHY sends a packet; Link lights when the PHY has found a link partner.
DS10, DS11, DS09	LED	—	4	Ethernet PHY mode LEDs. Used for display of Speed, Duplex, and Collision.
J21	LAN network connection	—	5	RJ45 connector for Ethernet PHY.
J22, J23	Test points	—	4	Test points for MII interface between PHY and DS33R11.
J19, J20 J24	WAN Network Connection	—	11	T1E1 coax and RJ45 connectors for network.
J17, J25	Jumper	Not installed	11	Connects adjacent coax connector to ground.
Y03	Clock	—	10	100MHz SDRAM clock for DS33R11.
J28	Configuration pins (See next 10 rows for details.)	Schematic Page 23		Pin bias for DS3150. When not jumpered, this pin is pulled to ground, jumper drives pin to VCC. A basic description of the pin function is given below. Refer to the data sheet for full detail.
J28.20	DS3150 pin (ZCSE)	Not installed		0 = B3ZS/HDB3 encoder/decoder enabled (NRZ interface enabled) 1 = B3ZS/HDB3 encoder/decoder disabled (bipolar interface enabled)
J28.18	DS3150 pin (TTS)	Installed		0 = tri-state the transmit output driver, disable the jitter attenuator in the transmit path 1 = enable the transmit output driver, disable the jitter attenuator in the transmit path
J28.16	DS3150 pin (TESS)	Installed		0 = E3 1 = T3 (DS3)
J28.14	DS3150 pin (TDS1)	Not installed		00=Transmit normal data clocked in on TPOS/TNRZ and TNEG
J28.12	DS3150 pin (TDS0)	Not installed		11=Transmit PRBS
J28.10	DS3150 pin (RMON)	Not installed		0 = disable the monitor preamp, disable the jitter attenuator in the receive path 1 = enable the monitor preamp, disable the jitter attenuator in the receive path
J28.8	DS3150 pin (LBKS)	Installed		0 = analog loopback enabled 1 = no loopback enabled
J28.6	DS3150 pin (LBO)	Installed		0 = cable length 225ft 1 = cable length < 225ft

SILKSCREEN REFERENCE	FUNCTION	BASIC SETTING	SCHEMATIC PAGE	DESCRIPTION
J28.4	DS3150 pin (ICE)	—		0 = Normal RCLK/Normal TCLK: update RPOS/RNRZ and RNEG/RLCV on falling edge of RCLK; sample TPOS/TNRZ and TNEG on rising edge of TCLK 1 = Normal RCLK/Inverted TCLK: update RPOS/RNRZ and RNEG/RLCV on falling edge of RCLK; sample TPOS/TNRZ and TNEG on falling edge of TCLK
J28.2	DS3150 pin (EFE)	Not installed		0 = enhanced features disabled 1 = enhanced features enabled
JP09	Clock selection	Pins 3+2 jumpered	23	Selects DS3150 MCLK. Jumper pins 1+2 for MCLK = RCLK; jumper pins 3+2 for MCLK = OSC_YB01.
DS12, DS13, DS14	LED	—	23	DS3150 LEDs for PRBS, LOS and DM.
J38, J39	BNC	—	23	DS3150 BNC network interface.
JP05–JP08	Serial backplane	User config	18	Jumper pins 1+2 to select DS21348 T1E1, jumper pins 2+3 to select DS3150.
J29	Configuration pins (See next 10 rows for details.)			Pin bias for DS21348. When not jumpered, this pin is pulled to ground, jumper drives pin to VCC. A basic description of the pin function is given below. Refer to the data sheet for full details.
J29.1	DS21348 pin (CS_EGL)			0 = -12dB (short haul) 1 = -43dB (long haul)
J29.3	DS21348 pin (RD_ETS)			0 = E1 1 = T1
J29.5	DS21348 pin (WR_NRZ)			0 = Bipolar data at RPOS/RNEG and TPOS/TNEG 1 = NRZ data at RPOS and TPOS or TNEG; RNEG outputs a positive-going pulse when device receives a BPV, CV, or EXZ
J29.7	DS21348 pin (ALE/SCLKE)			0 = disable 2.048MHz synchronization transmit and receive mode 1 = enable 2.048Hz synchronization transmit and receive mode
J29.9	DS21348 pin (VSM)			Should be tied low for 3.3V operation.
J29.11	DS21348 pin (LO)			Transmit LIU waveshape select bits. (Refer to the DS21348 data sheet Table 7-1 and 7-2.)
J29.13	DS21348 pin (DJA)			0 = jitter attenuator enabled 1 = jitter attenuator disabled
J29.15	DS21348 pin (JAMUX)			E1 (ETS = 0) JAMUX MCLK = 2.048MHz 0 T1 (ETS = 1) MCLK = 2.048MHz 1 MCLK = 1.544MHz 0
J29.17	DS21348 pin (JAS)			0 = place the jitter attenuator on the receive side 1 = place the jitter attenuator on the transmit side
J29.19	DS21348 pin (HBE)			0 = enable HDB3 (E1)/B8ZS (T1) 1 = disable HDB3 (E1)/B8ZS (T1)

SILKSCREEN REFERENCE	FUNCTION	BASIC SETTING	SCHEMATIC PAGE	DESCRIPTION
J31	Configuration pins (See next 10 rows for details)	Schematic Page 25		Pin bias for DS21348. When not jumpered, this pin is pulled to ground, jumper drives pin to VCC. A basic description of the pin function is given below. Refer to the data sheet for full details.
J31.1	DS21348 pin (MM1)			Monitor mode selection. See Table 2-11 in the DS21348 data sheet.
J31.3	DS21348 pin (MM0)			Loop 1, Loop 0: 11 = RLB 10 = LLB 01 = ALB
J31.5	DS21348 pin (LOOP1)			Transmit data control (pattern vs. TPOS/TNEG)
J31.7	DS21348 pin (LOOP0)			0 = normal transmitter operation 1 = powers down the transmitter and tri-states the TTIP and TRING pins
J31.9	DS21348 pin (TX1)			0 = update RNEG/RPOS on rising edge of RCLK; sample TPOS/TNEG on falling edge of TCLK 1 = update RNEG/RPOS on falling edge of RCLK; sample TPOS/TNEG on rising edge of TCLK
J31.11	DS21348 pin (TX0)			Set high to tri-state all outputs and I/O pins.
J31.13	DS21348 pin (TPD)			Selects receive termination in conjunction with RT1.
J31.15	DS21348 pin (CES)			
J31.17	DS21348 pin (TEST)			
J31.19	DS21348 pin (PBTS/RT0)			
J36	Configuration pins (See next three rows for details.)	Schematic Page 25		Pin bias for DS21348. When not jumpered, this pin is pulled to ground, jumper drives pin to VCC. A basic description of the pin function is given below. Refer to the data sheet for full details.
J36.2	DS21348 pin (L1)			Transmit LIU waveshape select bits. (Refer to the DS21348 data sheet Table 7-1 and 7-2.)
J36.4	DS21348 pin (L2)			Transmit LIU waveshape select bits. (Refer to the DS21348 data sheet Table 7-1 and 7-2.)
J36.6	DS21348 pin (RT1)			The silkscreen on this pin is mislabeled. Should read RT1 with a function of selecting receive termination.
JP10	Clock selection			25 —
DS15	LED			25 —
J40, J41	Network connection			24 —
J27	DS33ZH11 pin (MODEC1)			21 —
J26	DS33ZH11 pin (HWMODE)			21 —
JPB01	Jumper			21 —
J30, J33	Test points		26	Test points for MII interface between PHY and DS33ZH11.
JP11	Clock selection	Pins 2+3 jumpered	18	Must be set with pins 1+2 jumpered. SDRAM oscillator does not meet jitter requirement of the Ethernet PHY.
J32, J35, J34	Jumpers	Not installed	26	Installation forces Ethernet PHY mode. When not installed, the PHY autonegotiates its settings

SILKSCREEN REFERENCE	FUNCTION	BASIC SETTING	SCHEMATIC PAGE	DESCRIPTION
DS19, DS20, DS21	LED	—	19	Activity LEDs for Ethernet PHY. Tx lights when PHY sends a packet; Link lights when the PHY has found a link partner.
DS16, DS17, DS18	LED	—	19	Ethernet PHY mode LEDs. Used for display of Speed, Duplex, and Collision.
SW02	Reset button	—	19	—
GROUND (banana plug)	Power supply ground	—	2	Redundant power supply connection (see top left of board).
VDD 3.3V (banana plug)	Power supply VDD	—	2	Redundant power supply connection (see top left of board).
YB01	DS3150 MCLK	—	23	44.736MHz, for use with DS3150 in T3 mode (bottom side of PC board)
YB02	DS21348 MCLK	—	25	1.544MHz, for use with DS21348 in T1 mode (bottom side of PC board)
YB04	Ethernet clock	—	18	25.000MHz driver for DS33ZH11 Ethernet PHY (bottom side of PC board).
YB03	SDRAM clock	—	21	100MHz SDRAM clock for DS33ZH11 (bottom side of PC board).
YB05	Spare oscillator	—	25	2.048MHz, for use with DS21348 in E1 mode (bottom side of PC board).
Y05	Spare oscillator	—	23	34.368MHz for use with DS3150 in E3 mode (bottom side of PC board).

ADDRESS MAP (ALL CARDS)

The external device address space begins at 0x81000000. All offsets given below are relative to this offset.

Table 3. Overview of Daughter Card Address Map

OFFSET	DEVICE	DESCRIPTION
0X0000 to 0X0087	FPGA	Processor board identification
0X1000 to 0X1FFF	DS33R11	DS33R11 Ethernet to Serial Engine. Uses CS_X1.
0X4000 to 0X4FFF		T1E1 portion of DS33R11. Uses CS_X4.

Registers in the DS33R11 can be easily modified using the ChipView host-based user-interface software with the definition files previously mentioned.

DS33R11 INFORMATION

For more information about the DS33R11, refer to the DS33R11 data sheet available on our website at www.maxim-ic.com/DS33R11.

DS33R11DK/DS33ZH11DK INFORMATION

For more information about the DS33R11DK/DS33ZH11DK, including software downloads, refer to the data sheet available on our website at www.maxim-ic.com/DS33R11DK.

TECHNICAL SUPPORT

For additional technical support, go to www.maxim-ic.com/support.

SCHEMATICS

The DS33R11/DS33ZH11DK schematics are featured in the following pages. As this is a hierarchical schematic some explanation is in order. The board is composed of two top-level hierarchical blocks: the DS33R11 block and the DS33ZH11, both of these are nested hierarchy blocks. The DS33R11 hierarchy block contains individual hierarchy blocks for the Ethernet PHY, DS33R11 and microprocessor portions of the design. The DS33ZH11 hierarchy block contains individual hierarchy blocks for the Ethernet PHY, DS33ZH11, T1E1 LIU, and the T3E3 LIU portions of the design.

All signals inside a hierarchy block are local, with exception for V_{CC} and ground. In-port and out-port connectors are used to allow signals inside a hierarchy block to become accessible as pins on the hierarchy blocks symbol. From here blocks are wired together as if they were ordinary components. The system diagram is shown again below, with schematic page numbers given for each functional block.

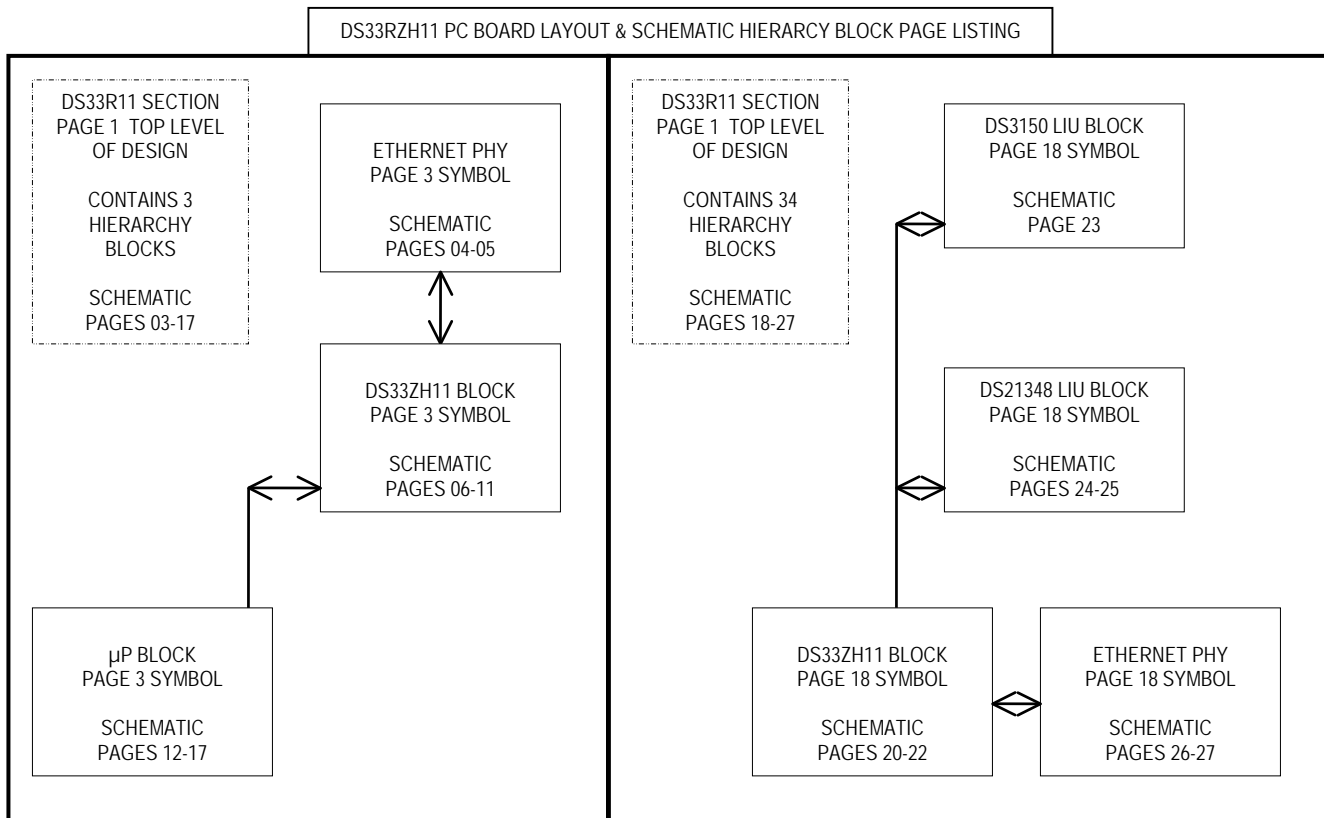

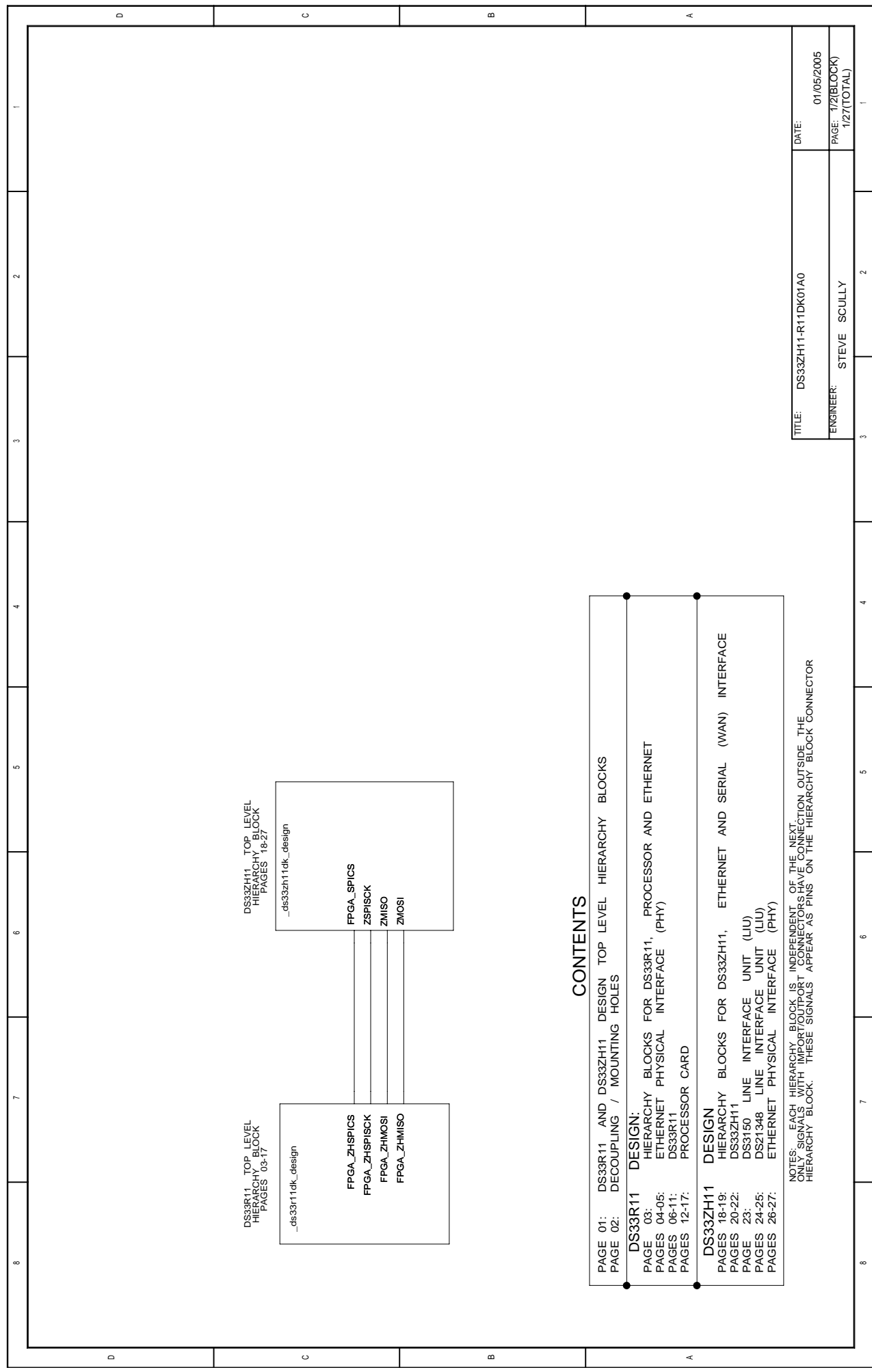

CONTENTS

PAGE 01: DS33R11 AND DS33ZH11 DESIGN TOP LEVEL HIERARCHY BLOCKS
 PAGE 02: DECOUPLING / MOUNTING HOLES

DS33R11 DESIGN:
 PAGE 03: HIERARCHY BLOCKS FOR DS33R11, PROCESSOR AND ETHERNET
 PAGES 04-05: ETHERNET PHYSICAL INTERFACE (PHY)
 PAGES 06-11: DS33R11 PROCESSOR CARD
 PAGES 12-17: PROCESSOR CARD

DS33ZH11 DESIGN
 PAGES 18-19: HIERARCHY BLOCKS FOR DS33ZH11, ETHERNET AND SERIAL (WAN) INTERFACE
 PAGES 20-22: DS33ZH11
 PAGE 23: DS3150 LINE INTERFACE UNIT (LIU)
 PAGES 24-25: DS21348 LINE INTERFACE UNIT (LIU)
 PAGES 26-27: ETHERNET PHYSICAL INTERFACE (PHY)

NOTES: EACH HIERARCHY BLOCK IS INDEPENDENT OF THE NEXT. ONLY SIGNALS WITH IMPORT/EXPORT CONNECTORS HAVE CONNECTION OUTSIDE THE HIERARCHY BLOCK. THESE SIGNALS APPEAR AS PINS ON THE HIERARCHY BLOCK CONNECTOR

TITLE: DS33ZH11-R11DK01A0	DATE: 01/05/2005
ENGINEER: STEVE SCULLY	PAGE: 1/2(BLOCK) 1/27(TOTAL)

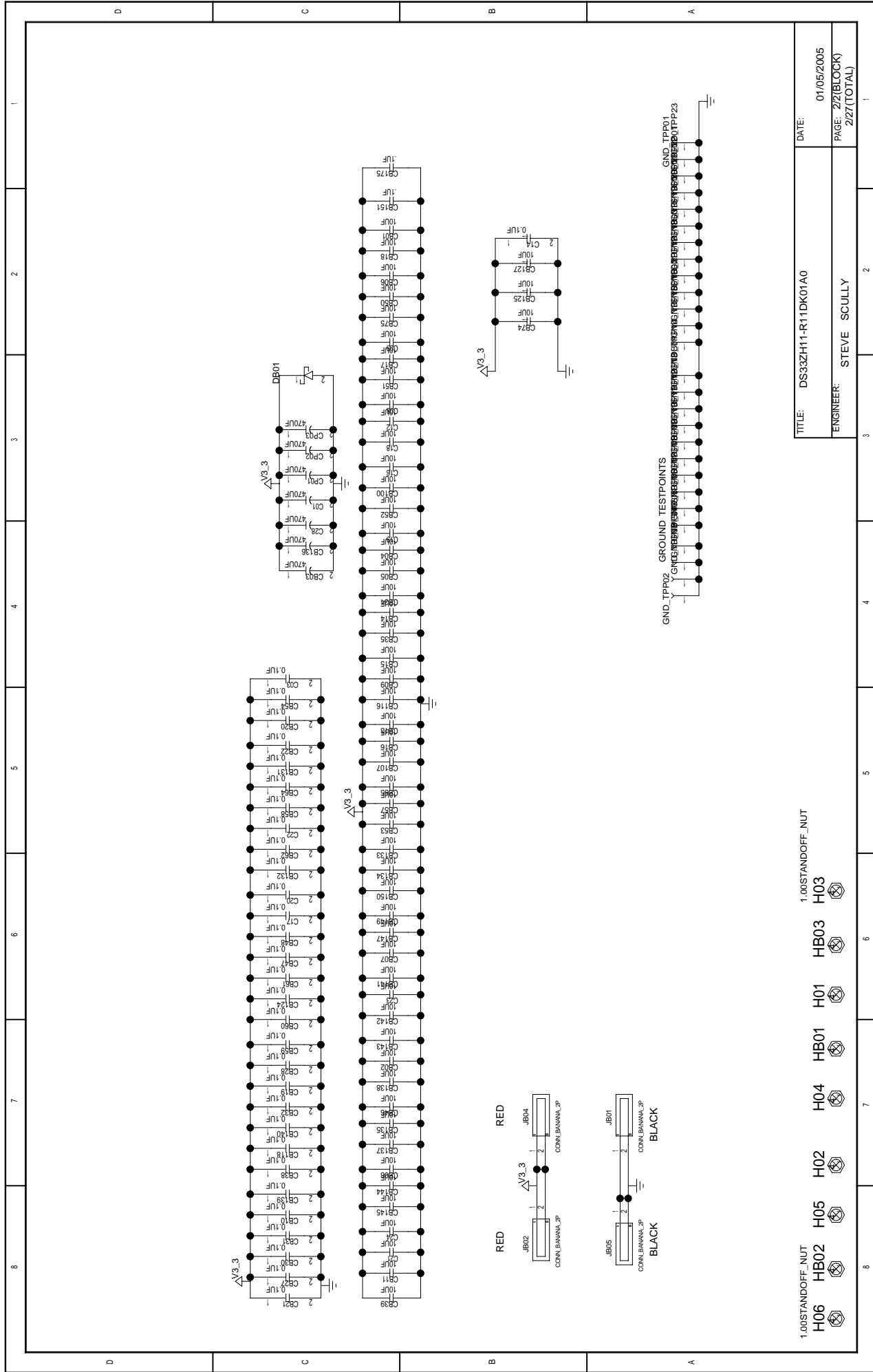

1.00STANDOFF_NUT
 H06 HB02 H05 H02 H01 HB01 H04 HB03 H03

BLOCK NAME: _ztopdfn_ PARENT BLOCK: <CON_PARENT_NAME>

DS33R11 DESIGN KIT

NOTES: ALL HIERARCHY BLOCK NAMES END IN _DN. PINS ON HIERARCHY BLOCKS DO NOT HAVE PIN NUMBERS (BUT PINS ON SYMBOLS DO). SIGNALS INSIDE A HIERARCHY BLOCK ARE LOCAL TO THAT BLOCK. THE SIGNAL TEMP IN BLOCK_A_DN IS DIFFERENT THAN TEMP IN BLOCK_B_DN. PAGE NUMBERS (BOTTOM RIGHT) ARE LISTED BY BOTH THE PAGE NUMBER IN THE BLOCK, AND BY THE PAGE NUMBER WITHIN THE ENTIRE DESIGN. CROSS REFERENCE INDICATORS ARE REFERENCEING A GIVEN NET TO OTHER PAGES IN THE DESIGN (PAGE NUMBER GIVEN IS ACCORDING TO ENTIRE DESIGN, NOT THE CURRENT BLOCK)

PROCESSOR HIERARCHY BLOCK
PAGES 12-17

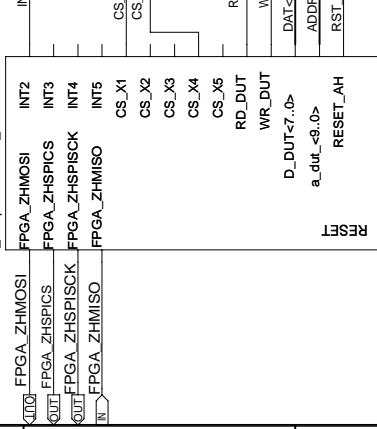

R11 HIERARCHY BLOCK
PAGES 06-11

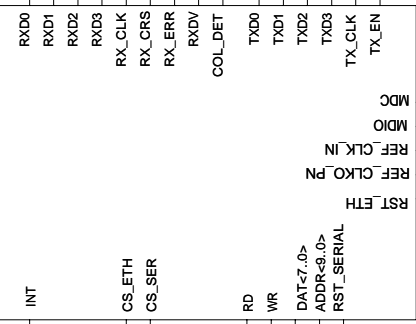

M11 ETHERNET HIERARCHY BLOCK
PAGES 04-05

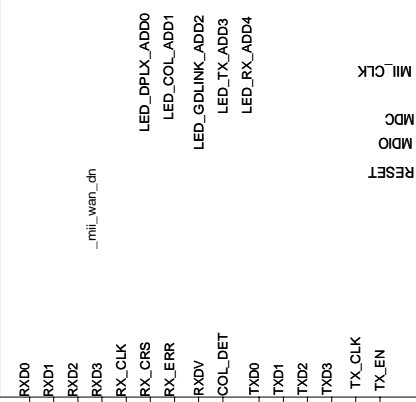

TITLE: DS33ZH11-R11DK01A0	DATE: 01/05/2005
ENGINEER: STEVE SCULLY	PAGE: 17/(BLOCK) 3/27(TOTAL)

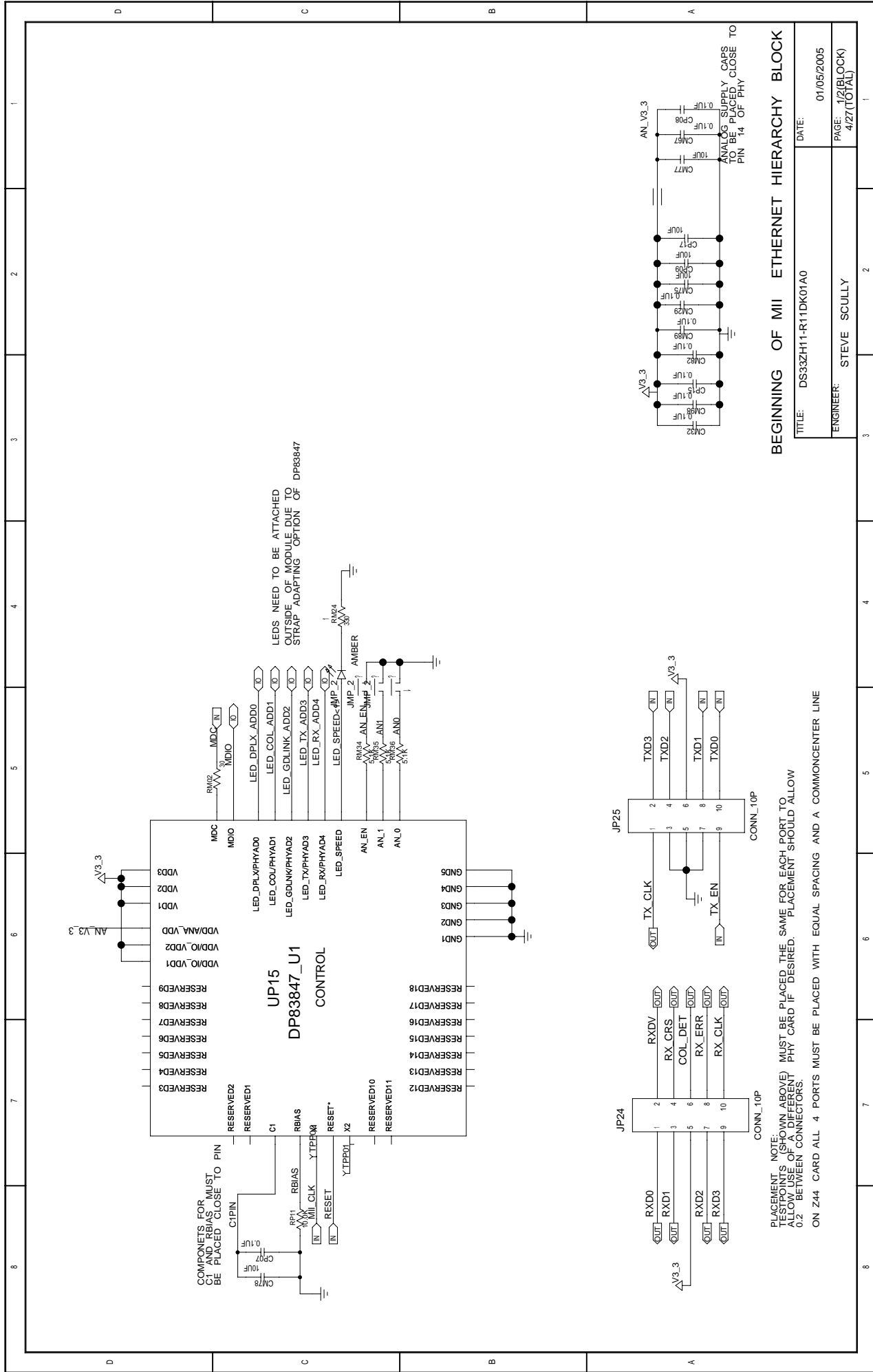

LEDS NEED TO BE ATTACHED OUTSIDE OF MODULE DUE TO STRAP ADAPTING OPTION OF DP83847

BEGINNING OF MII ETHERNET HIERARCHY BLOCK

TITLE:	DS33ZH11-R11DK01A0	DATE:	01/05/2005
ENGINEER:	STEVE SCULLY	PAGE:	1/2 (BLOCK) 4/27 (TOTAL)

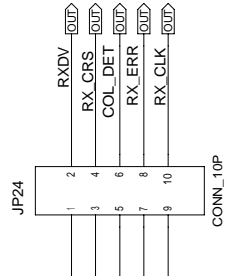
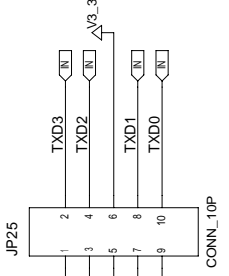

NOTE: PLACEMENT (SHOWN ABOVE) MUST BE PLACED THE SAME FOR EACH PORT TO ALLOW USE OF A DIFFERENT PHY CARD IF DESIRED. PLACEMENT SHOULD ALLOW 0.2" BETWEEN CONNECTORS.
ON Z44 CARD ALL 4 PORTS MUST BE PLACED WITH EQUAL SPACING AND A COMMONCENTER LINE

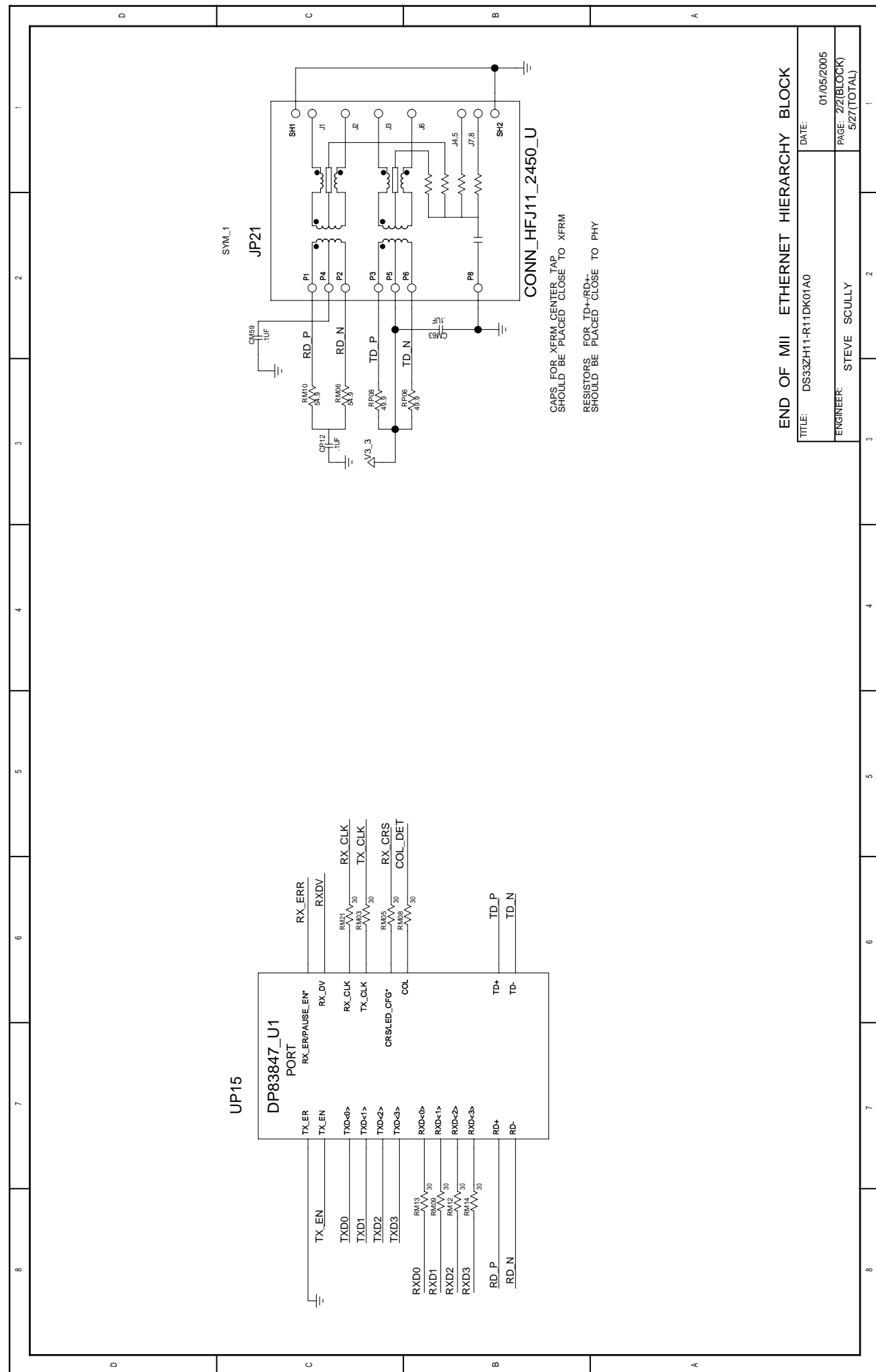

END OF MII ETHERNET HIERARCHY BLOCK

TITLE:	DS33ZH11-R11DK01A0	DATE:	01/05/2005
ENGINEER:	STEVE SCULLY	PAGE:	2/2(BLOCK)
			5/27(TOTAL)

BLOCK NAME: _mii_wan_dn. PARENT BLOCK: _ds33T1Tk_design

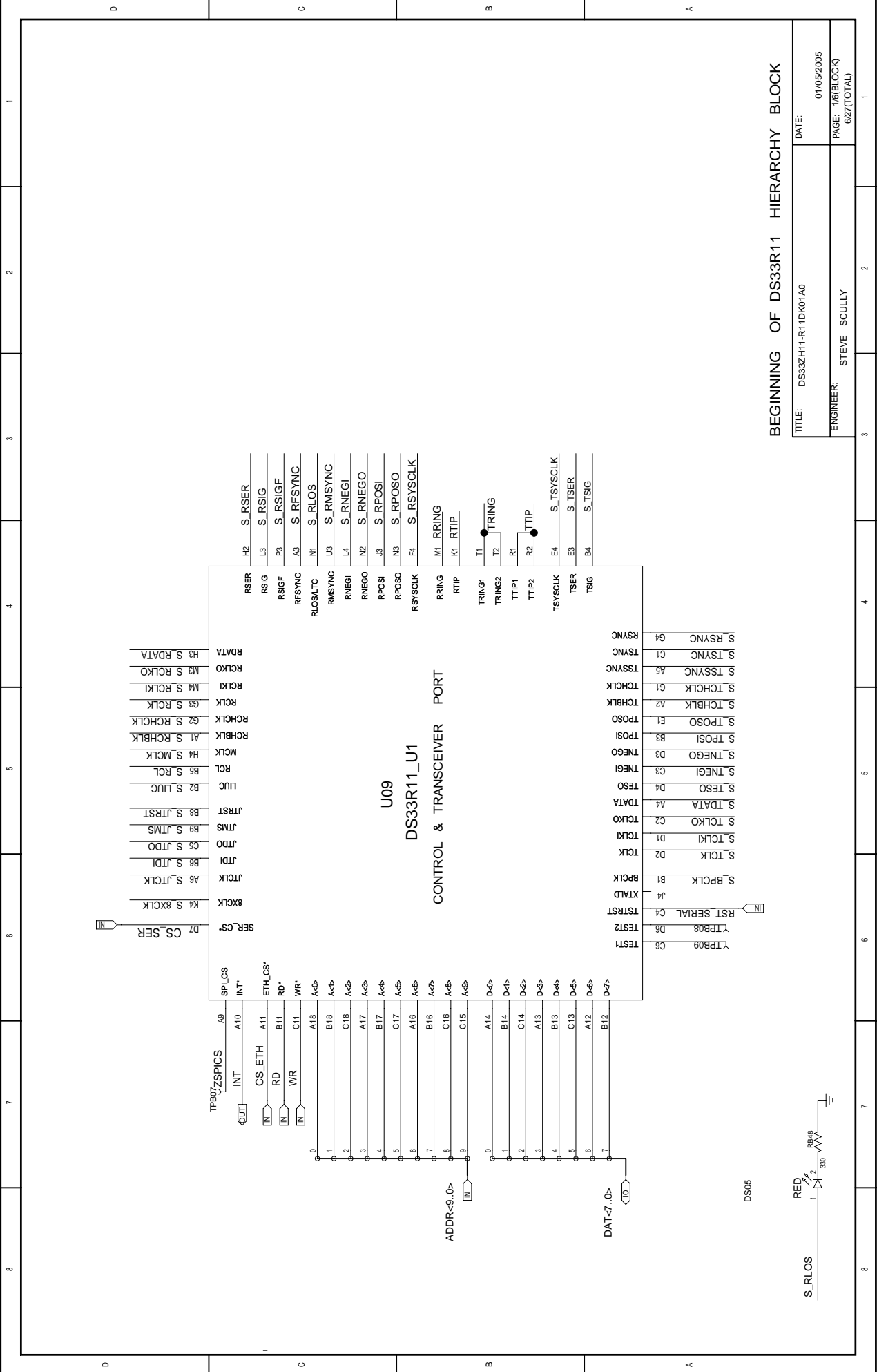

BEGINNING OF DS33R11 HIERARCHY BLOCK

TITLE: DS33ZH11-R1DK01A0	DATE: 01/05/2005
ENGINEER: STEVE SCULLY	PAGE: 16(BLOCK) 627(TOTAL)



BLOCK NAME: _z11andlan_dn_ PARENT BLOCK: _ds33r11dk_design_

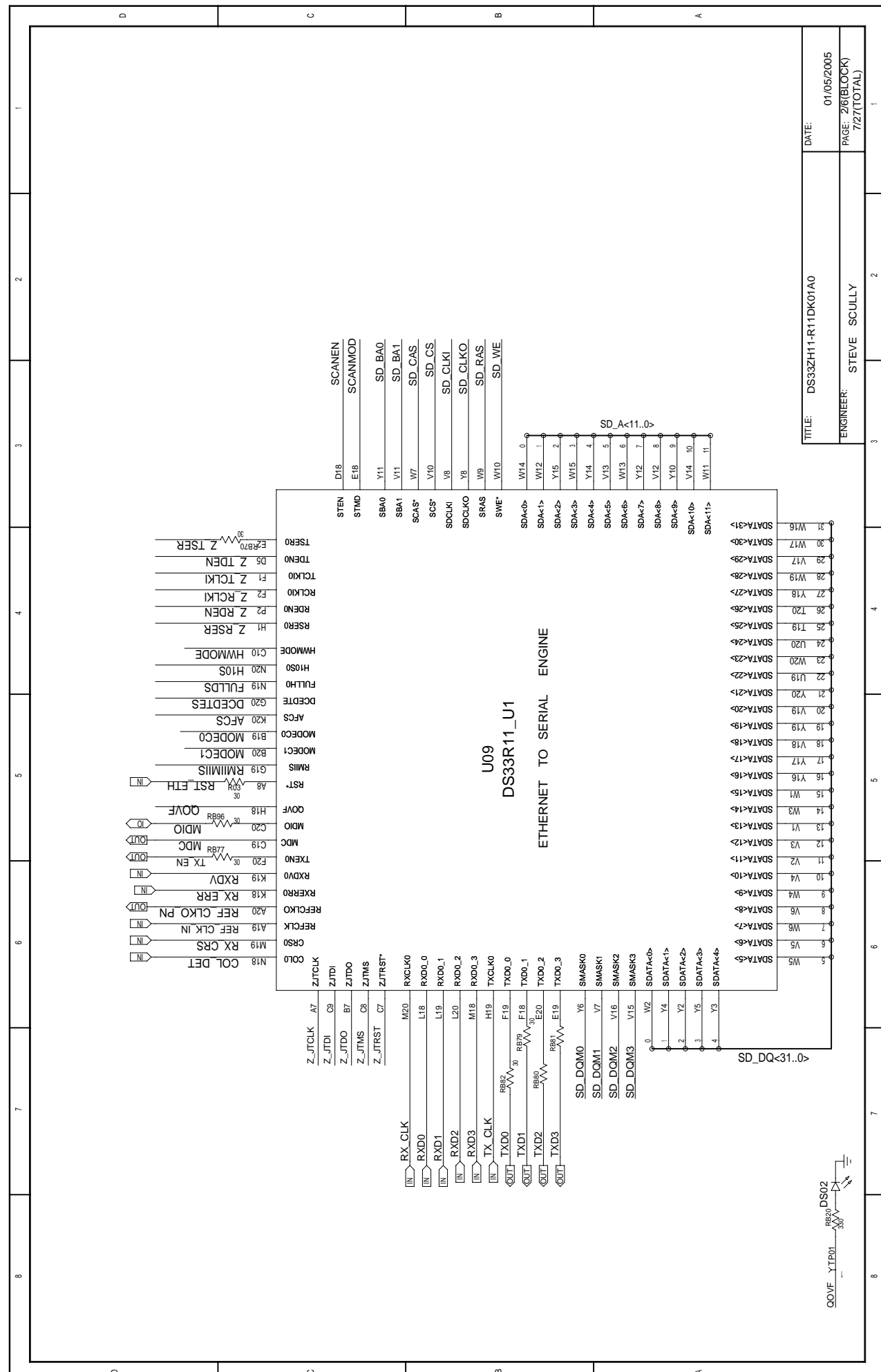

TITLE: DS33ZH11-R11DK01A0
 DATE: 01/05/2005
 ENGINEER: STEVE SCULLY
 PAGE: 2/6(BLOCK)
 7/27(TOTAL)

BLOCK NAME: _z1landian_dn_ PARENT_BLOCK: ds33r11dk_design1

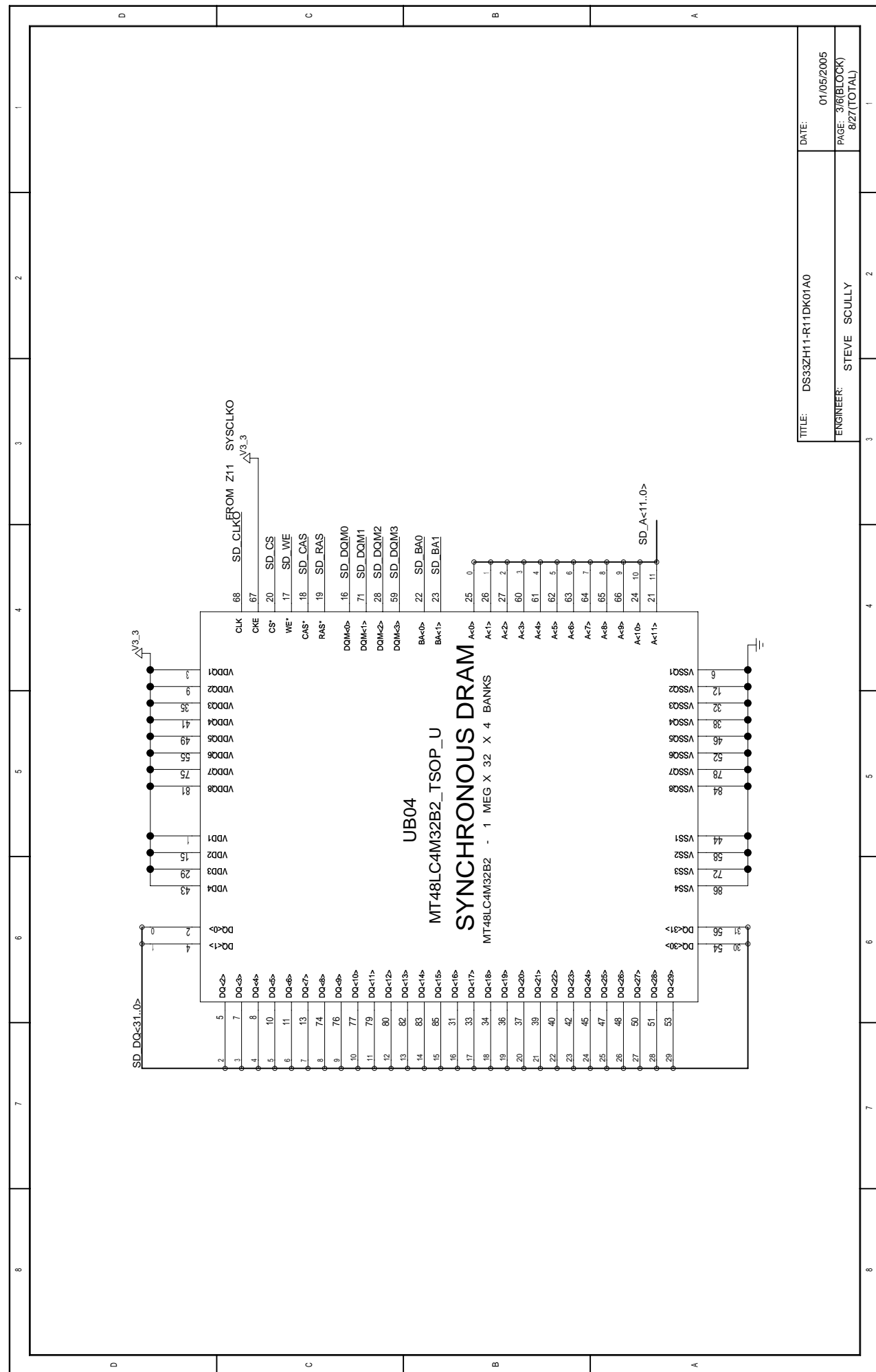

TITLE: DS33ZH11-R11DK01A0	DATE: 01/05/2005
ENGINEER: STEVE SCULLY	PAGE: 3/6(BLOCK) 8/27(TOTAL)

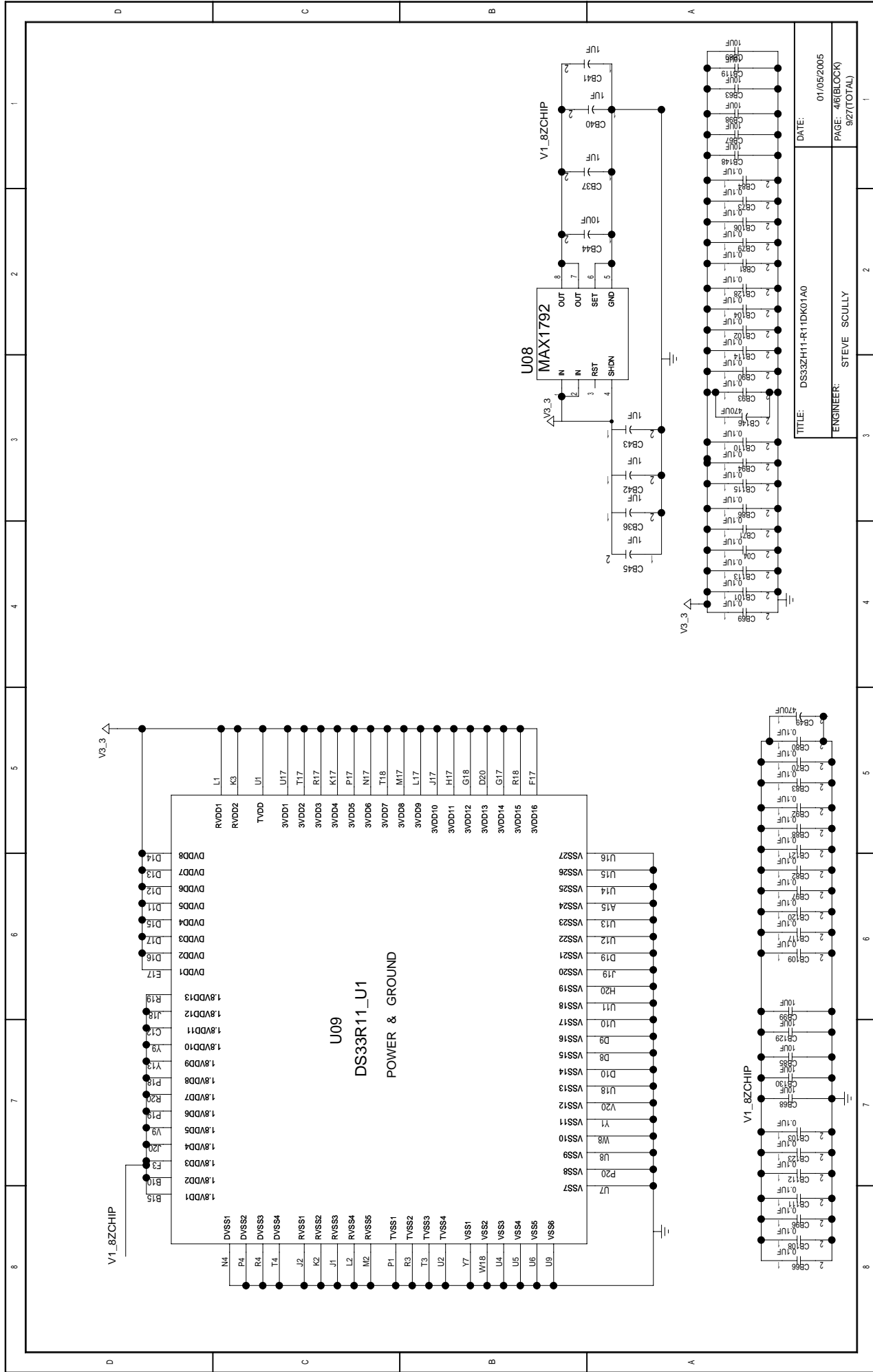

TITLE: DS33ZH11-R1DK01A0
 ENGINEER: STEVE SCULLY
 DATE: 01/05/2005
 PAGE: 46(BLOCK)
 9/27(TOTAL)

BLOCK NAME: _z11andlan_dn. PARENT BLOCK: _cas33r11dk_design

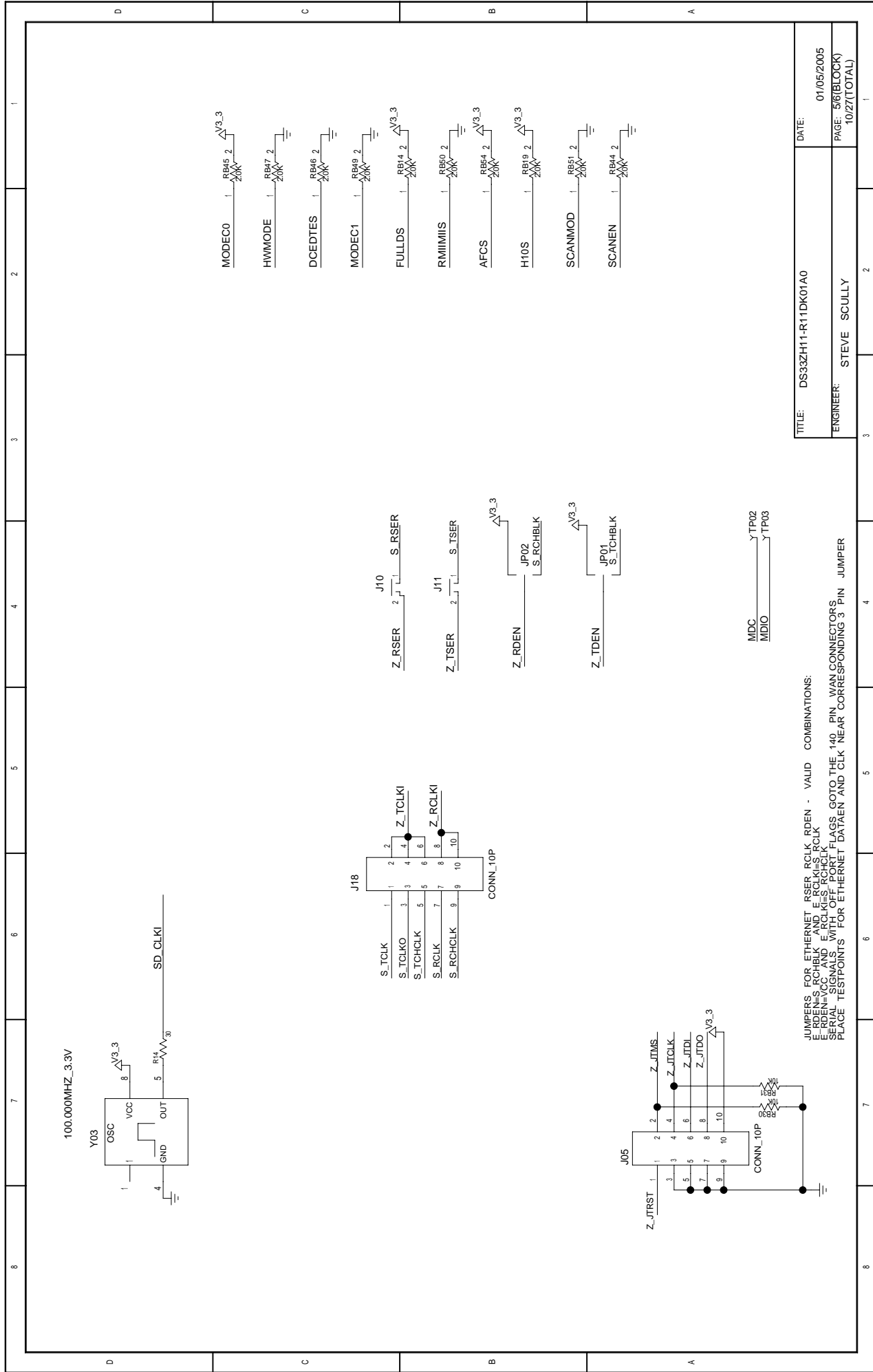

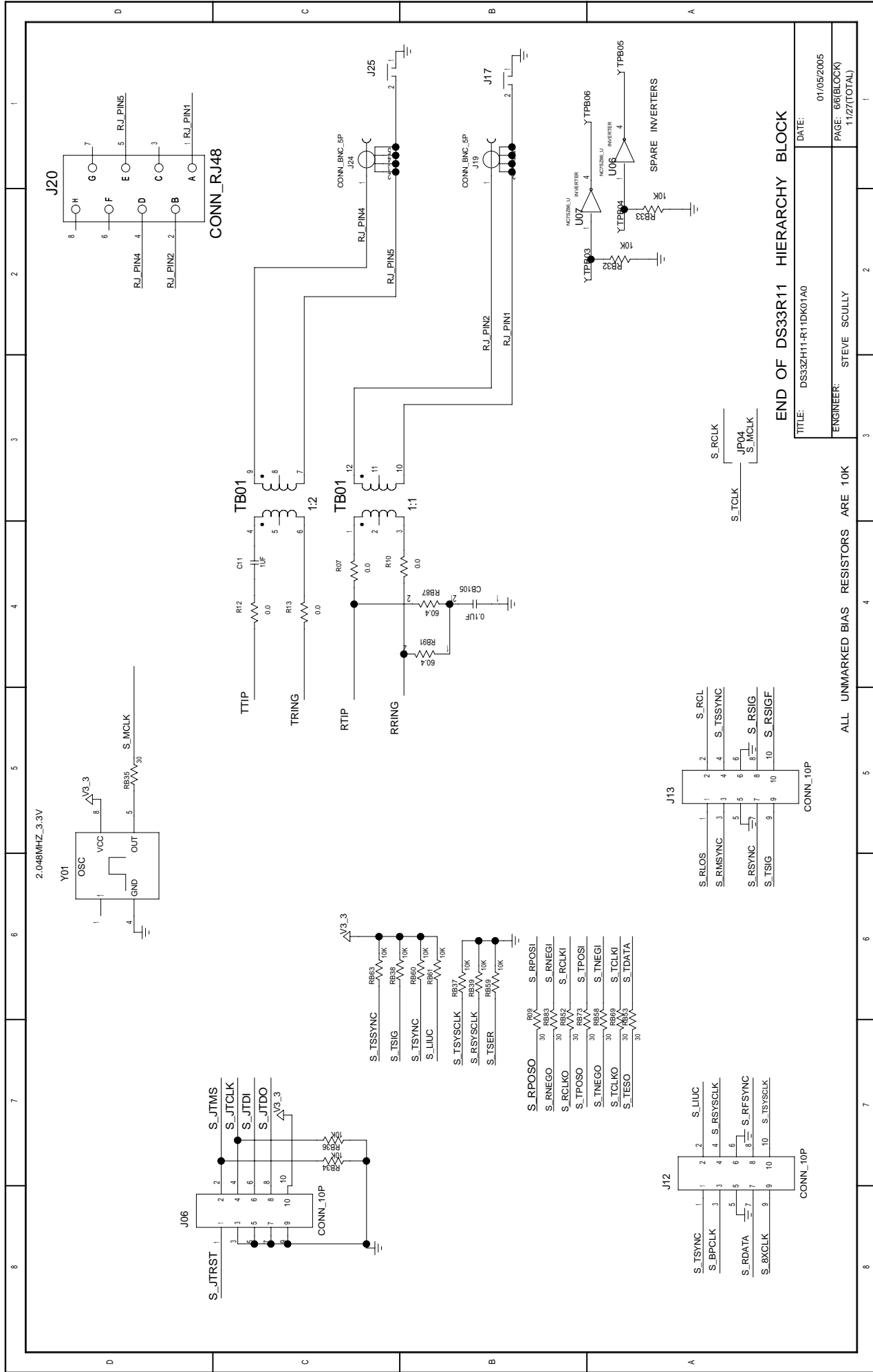

END OF DS33R11 HIERARCHY BLOCK

TITLE: DS33ZH11-R1DK01A0	DATE: 01/05/2005
ENGINEER: STEVE SCULLY	PAGE: 66(BLOCK)
	11/27(TOTAL)

ALL UNMARKED BIAS RESISTORS ARE 10K

BLOCK NAME: _z11andlan_dn_ PARENT BLOCK: _ds33r11dk_design_

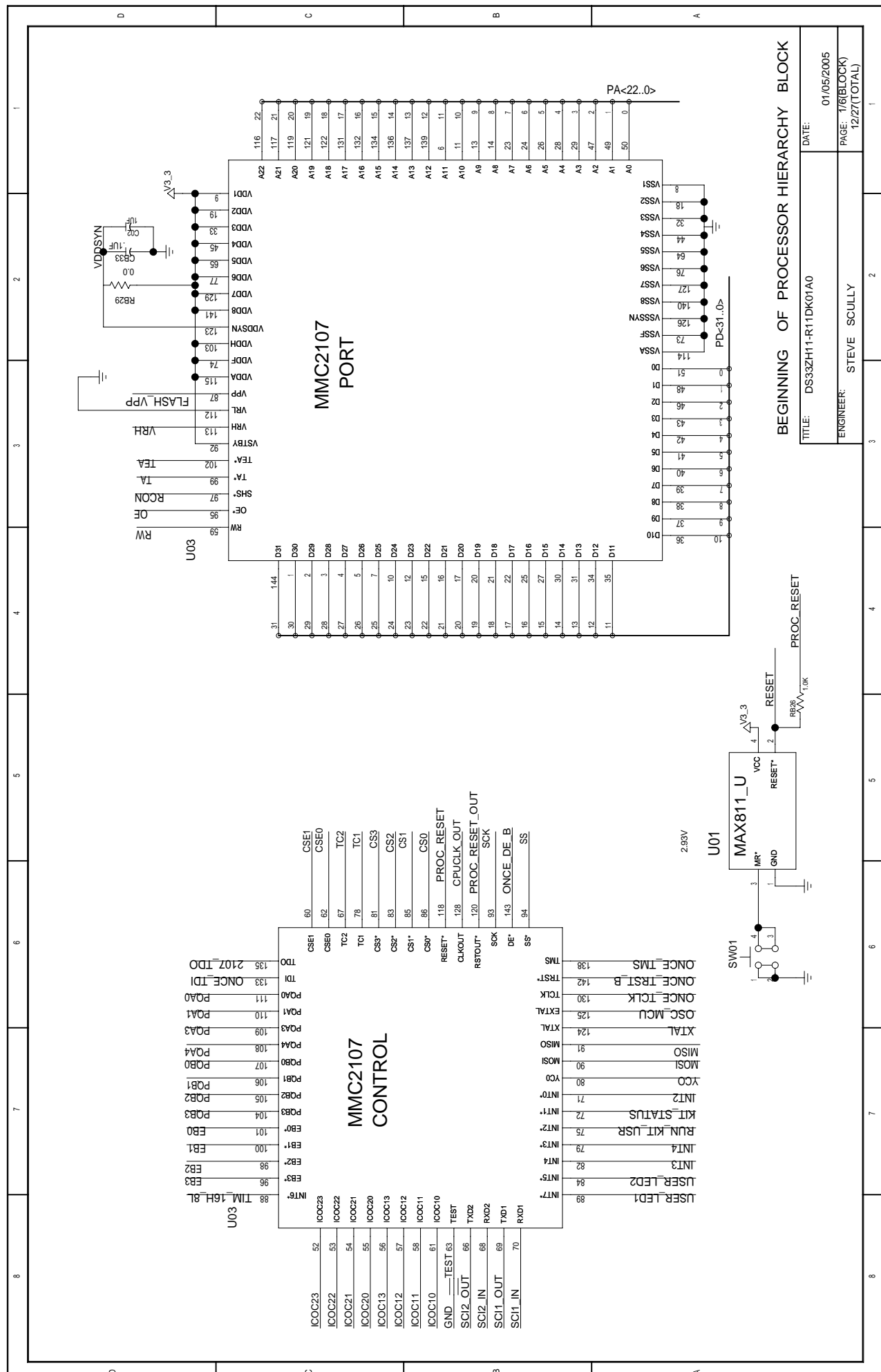

BEGINNING OF PROCESSOR HIERARCHY BLOCK

TITLE: DS33ZH11-R1DK01A0	DATE: 01/05/2005
ENGINEER: STEVE SCULLY	PAGE: 16(BLOCK) 12/27(TOTAL)

RESET CONFIGURATION

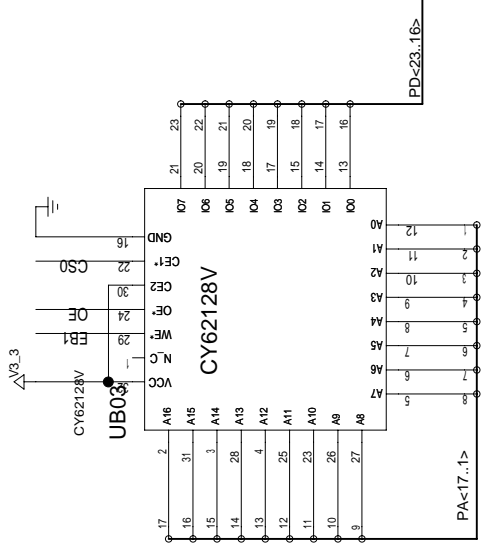
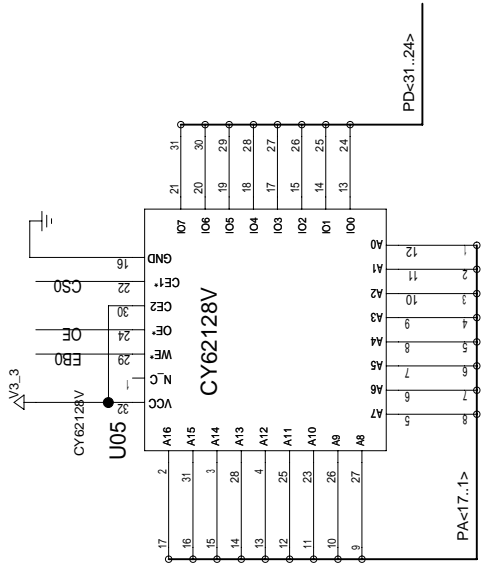
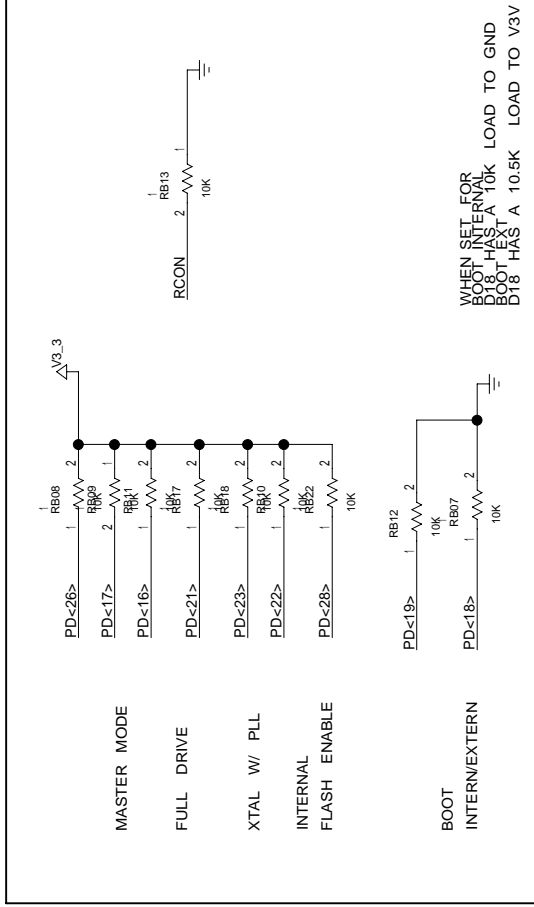

RESET AND CHIP CONFIGURATION

TITLE: DS33ZH11-R11DK01A0	DATE: 01/05/2005
ENGINEER: STEVE SCULLY	PAGE: 26(BLOCK) 13/27(TOTAL)

BLOCK NAME: _mpoiprocescard_dn. PARENT BLOCK: _ds33r1tdk_design

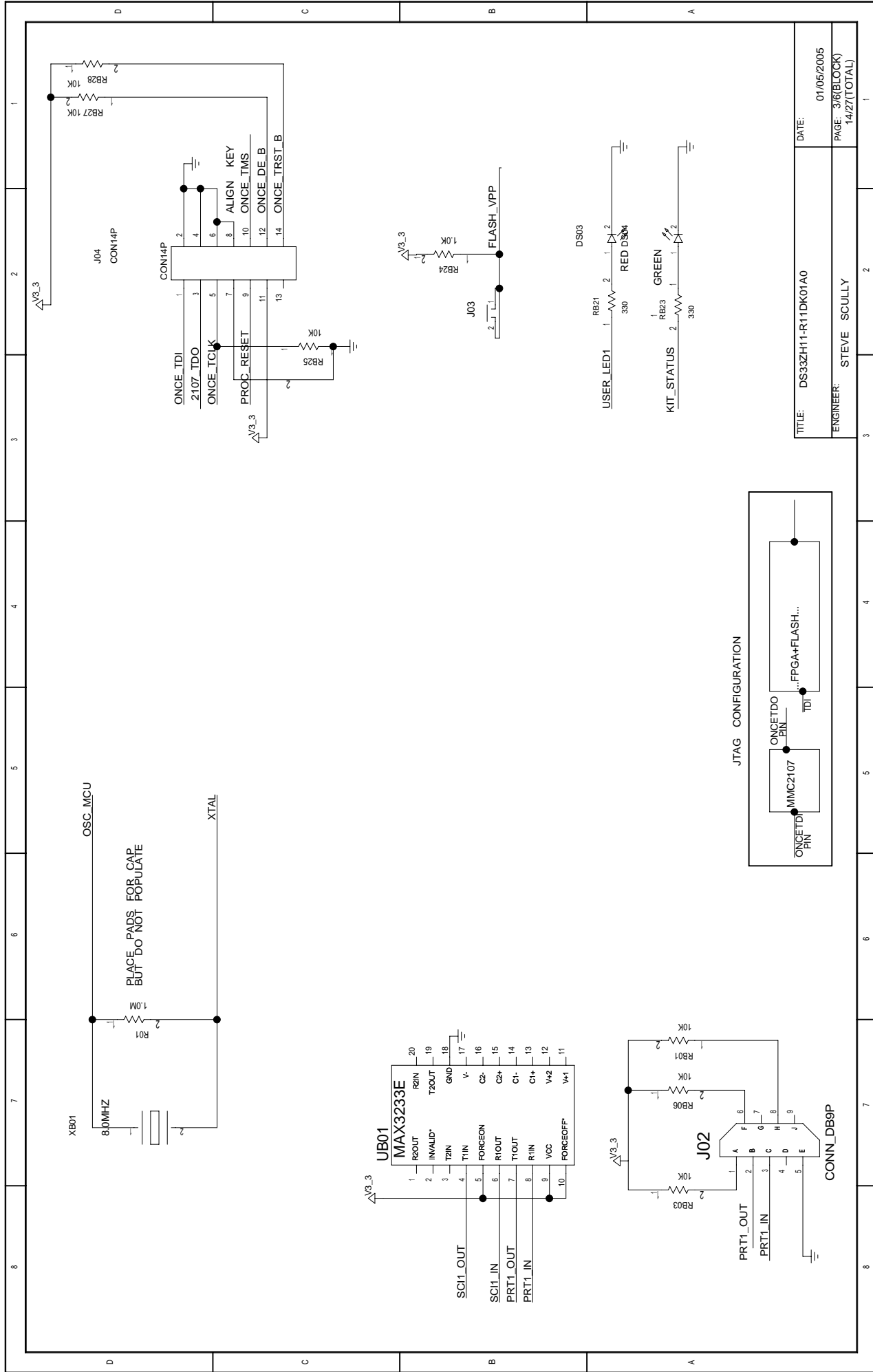

TITLE:	DS33ZH11-R11DK01A0	DATE:	01/05/2005
ENGINEER:	STEVE SCULLY	PAGE:	3/6(BLOCK)
			14/27(TOTAL)

BLOCK NAME: _mofproccard_dn. PARENT BLOCK: _ds33r1tdk_design

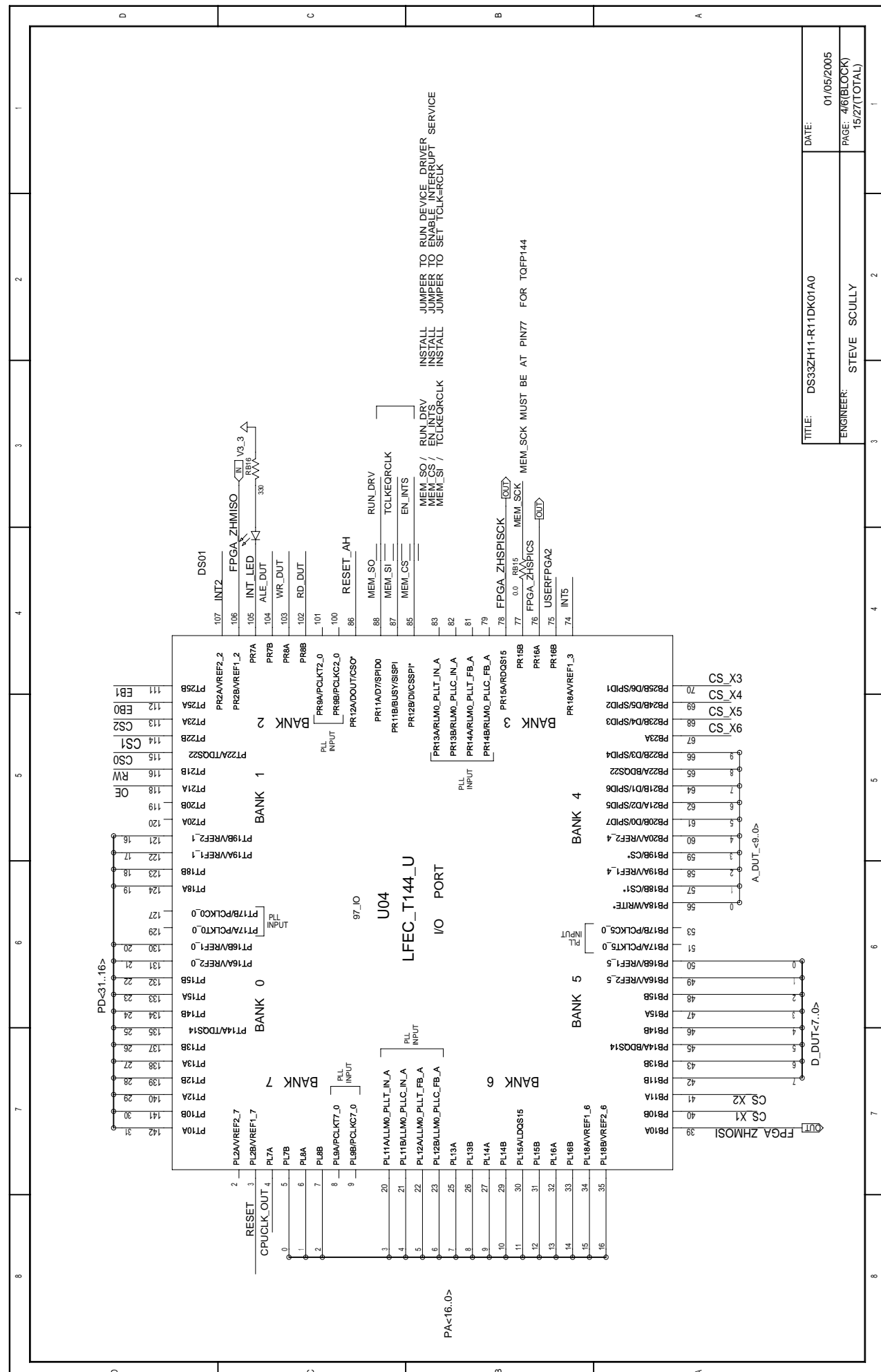

TITLE:	DS33ZH11-R11DK01A0	DATE:	01/05/2005
ENGINEER:	STEVE SCULLY	PAGE:	46(BLOCK)
			15/27(TOTAL)

BLOCK NAME:	_m0projocrescardr_dn.	PARENT BLOCK:	_ds33r11dk_design
-------------	-----------------------	---------------	-------------------

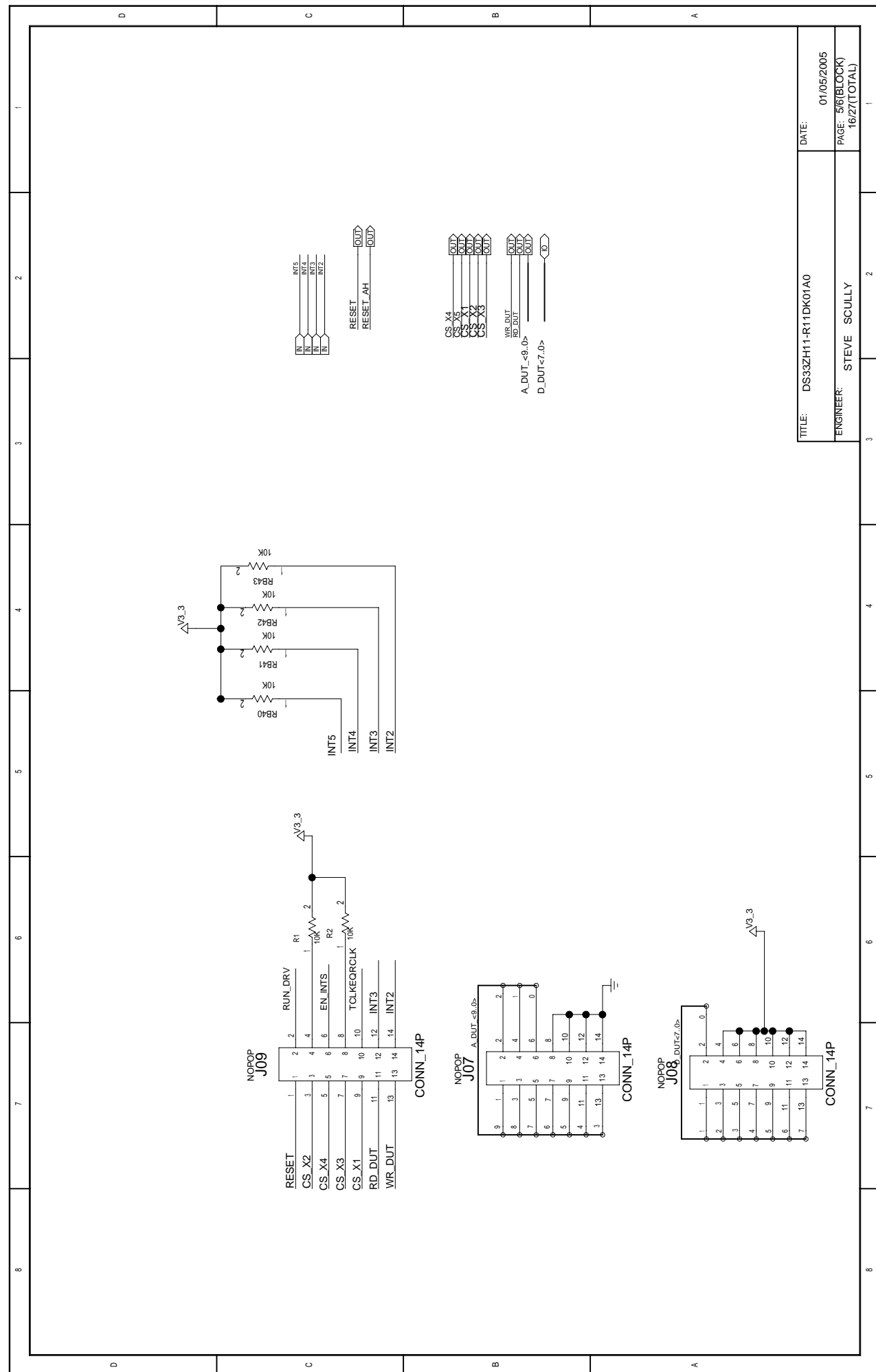

TITLE:	DS33ZH11-R11DK01A0	DATE:	01/05/2005
ENGINEER:	STEVE SCULLY	PAGE:	5/6(BLOCK)
			16/27(TOTAL)

BLOCK NAME: _mtoiprocescard_dn. PARENT BLOCK: _ds33r1tdk_design

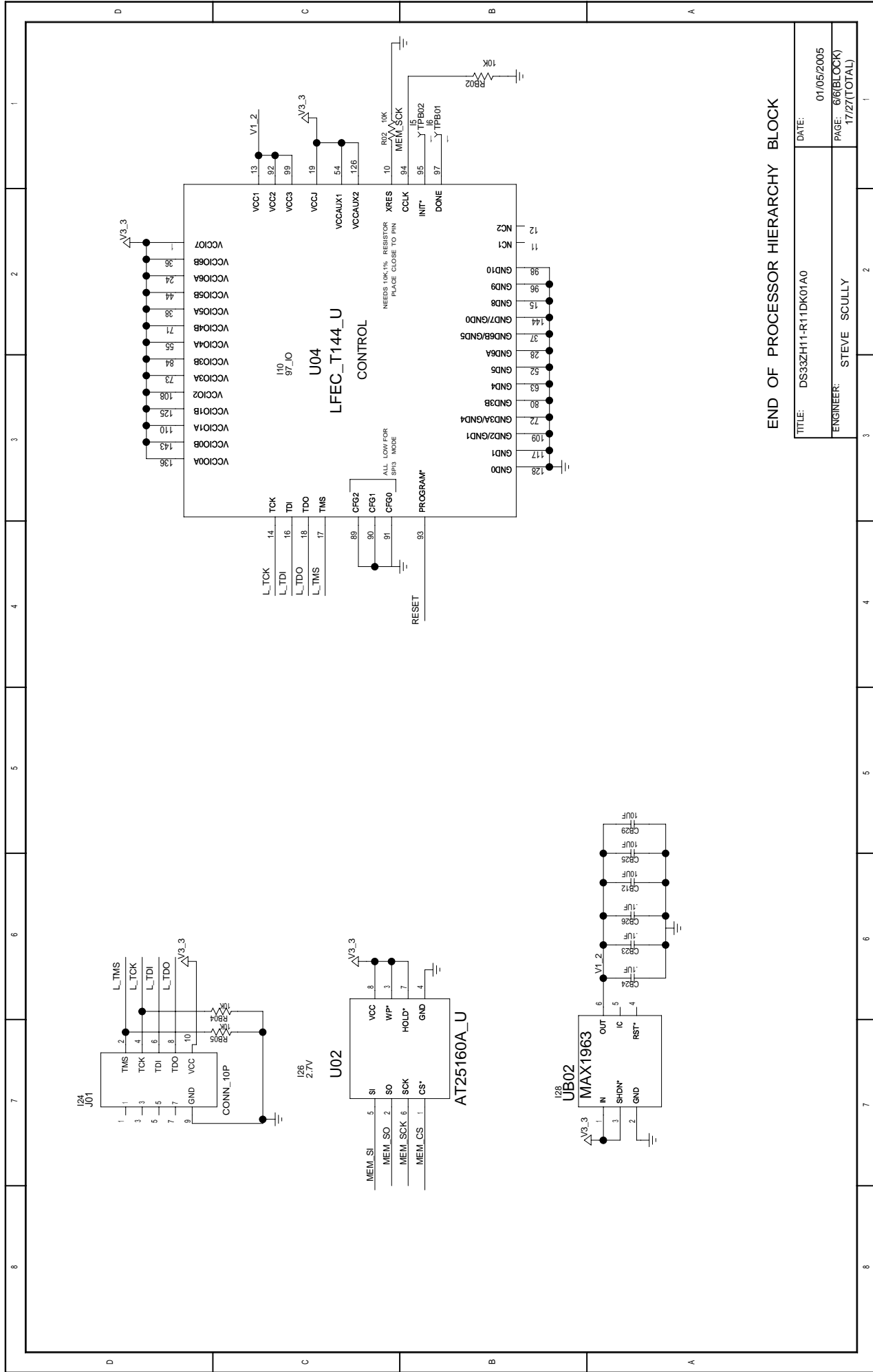

END OF PROCESSOR HIERARCHY BLOCK

TITLE:	DS33ZH11-R11DK01A0	DATE:	01/05/2005
ENGINEER:	STEVE SCULLY	PAGE:	6/6(BLOCK)
			17/27(TOTAL)

BLOCK NAME: _m0tprocessorcard_dn. PARENT BLOCK: _ds33z11tk_design

NOTES: ALL HIERARCHY BLOCK NAMES END IN _DN. PINS ON HIERARCHY BLOCKS DO NOT HAVE PIN NUMBERS (BUT PINS ON SYMBOLS DO). SIGNALS INSIDE A HIERARCHY BLOCK ARE LOCAL TO THAT BLOCK - THE SIGNAL TEMP IN BLOCK A.DN IS DIFFERENT THAN TEMP IN BLOCK B.DN. PAGE NUMBERS (BOTTOM RIGHT) ARE LISTED BY BOTH THE PAGE NUMBER IN THE BLOCK, AND BY THE PAGE NUMBER WITHIN THE ENTIRE DESIGN. CROSS REFERENCE INDICATORS ARE REFERENCEING A GIVEN NET TO OTHER PAGES IN THE DESIGN (PAGE NUMBER GIVEN IS ACCORDING TO ENTIRE DESIGN, NOT THE CURRENT BLOCK)

DS33ZH11 DESIGN KIT

DS33ZH11 HIERARCHY BLOCK
PAGES 20-22

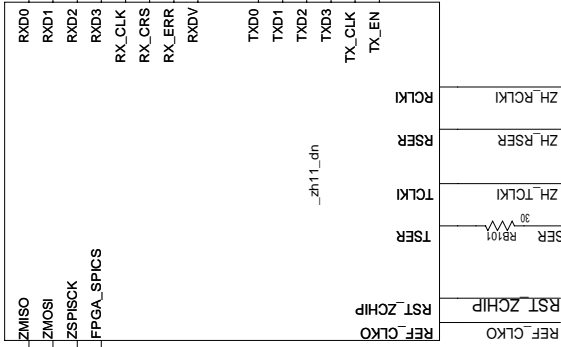

MII ETHERNET HIERARCHY BLOCK
PAGES 26-27

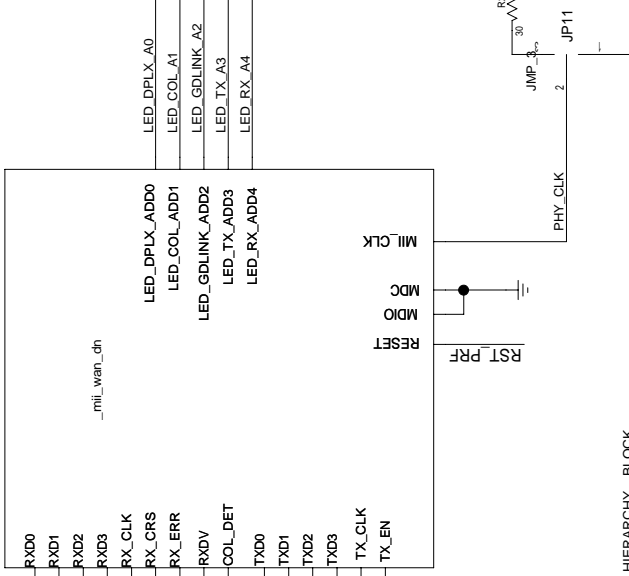

T1E1 LIU HIERARCHY BLOCK
PAGES 24-25

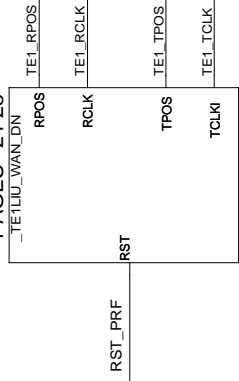

T3E3 LIU HIERARCHY BLOCK
PAGE 23

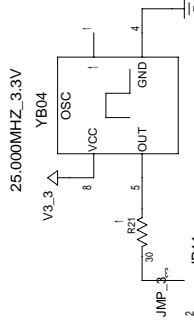
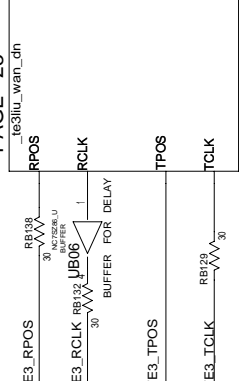

TITLE: DS33ZH11-R11DK01A0	DATE: 01/05/2005
ENGINEER: STEVE SCULLY	PAGE: 12/(BLOCK) 18/27(TOTAL)

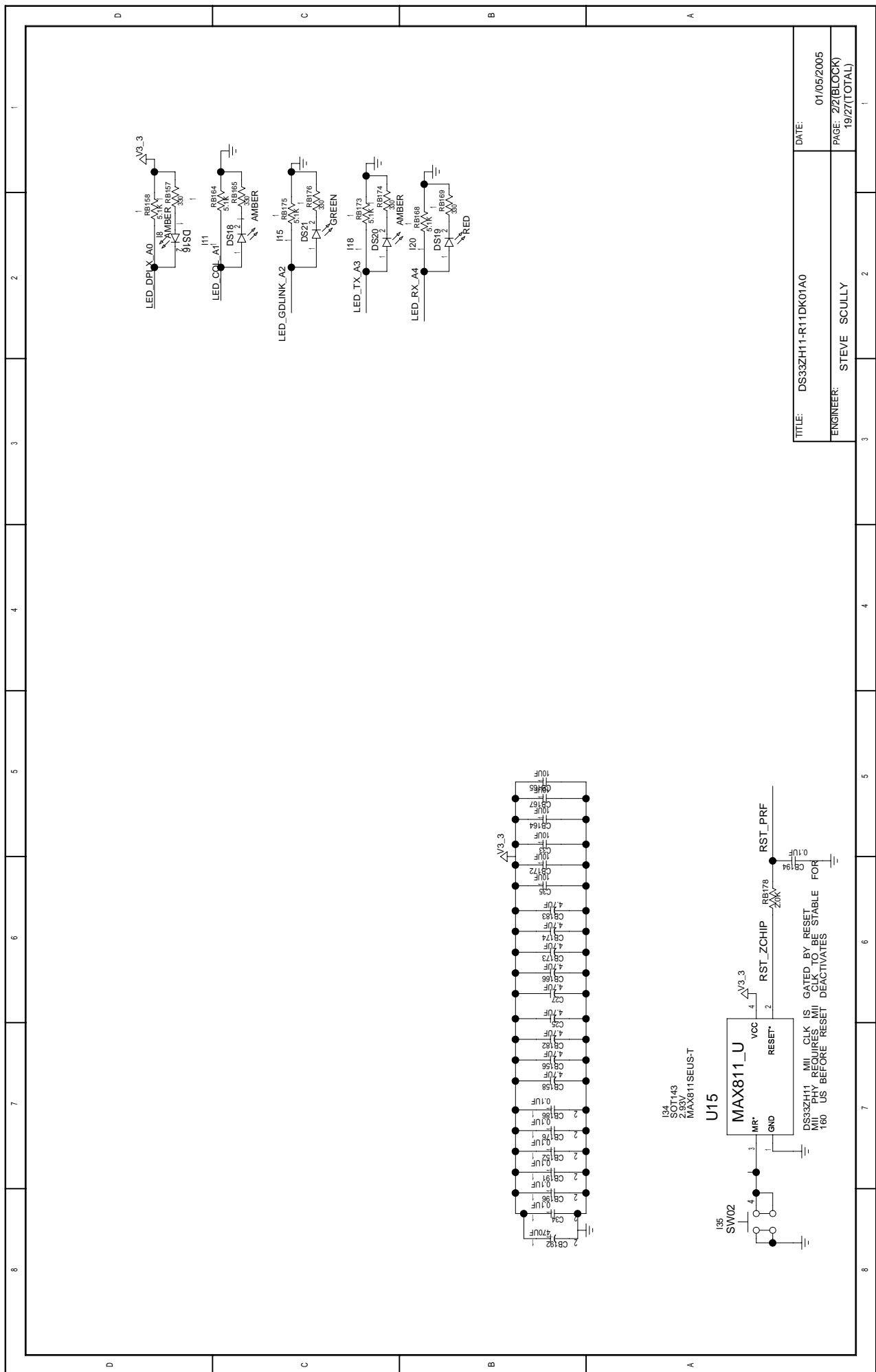

TITLE:	DS33ZH11-R11DK01A0	DATE:	01/05/2005
ENGINEER:	STEVE SCULLY	PAGE:	2/2(BLOCK)
			19/27(TOTAL)

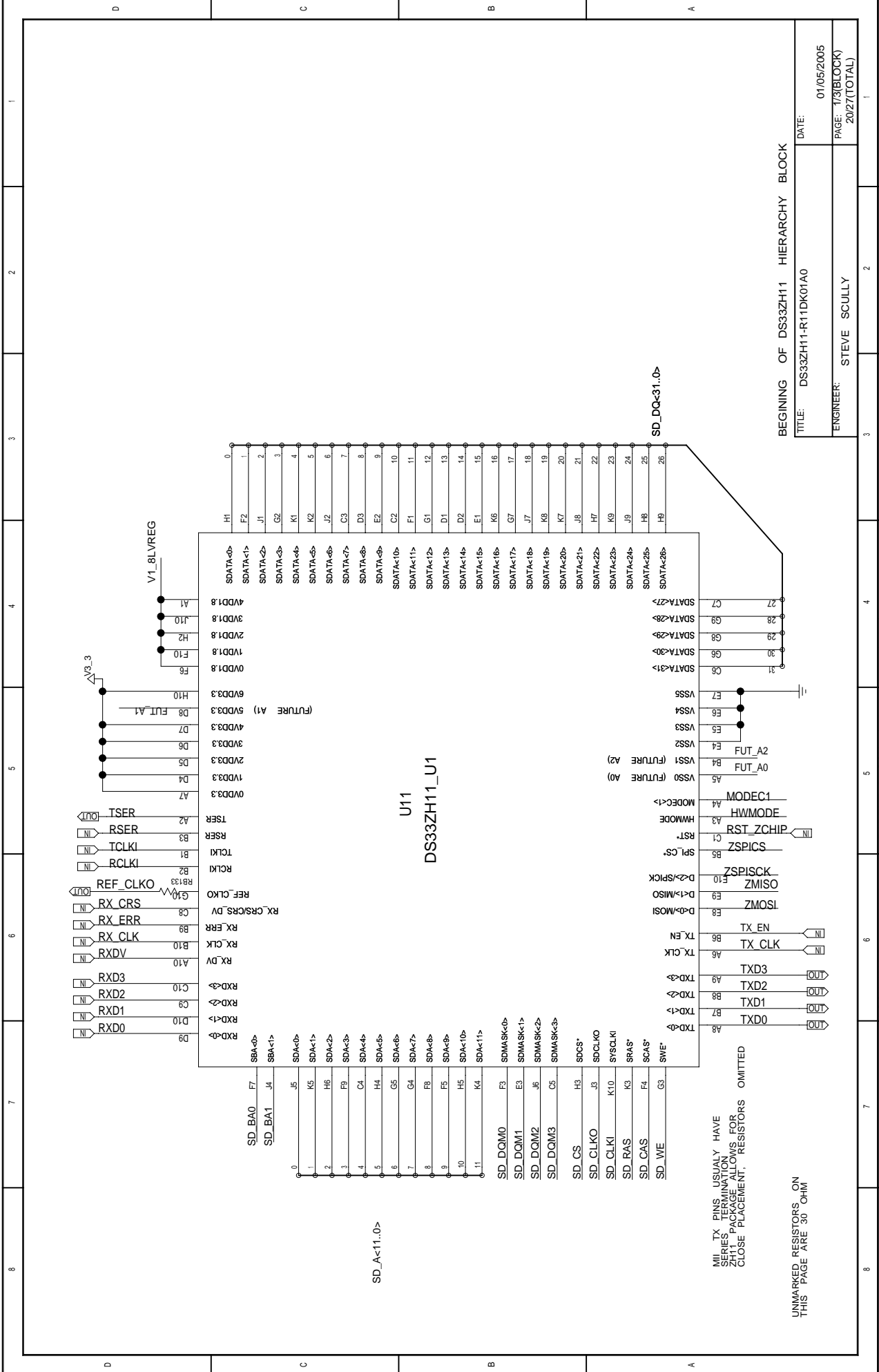

BEGINNING OF DS33ZH11 HIERARCHY BLOCK

TITLE: DS33ZH11-R11DK01A0 DATE: 01/05/2005

ENGINEER: STEVE SCULLY PAGE: 1/3(BLOCK) 20/27(TOTAL)

MIL TX PINS USUALLY HAVE SERIES TERMINATION PACKAGES. ALLOW CLOSE PLACEMENT. RESISTORS OMITTED

UNMARKED RESISTORS ON THIS PAGE ARE 30 OHM

PARENT BLOCK: _ds33zh11dk_design

BLOCK NAME: _zh11_dn

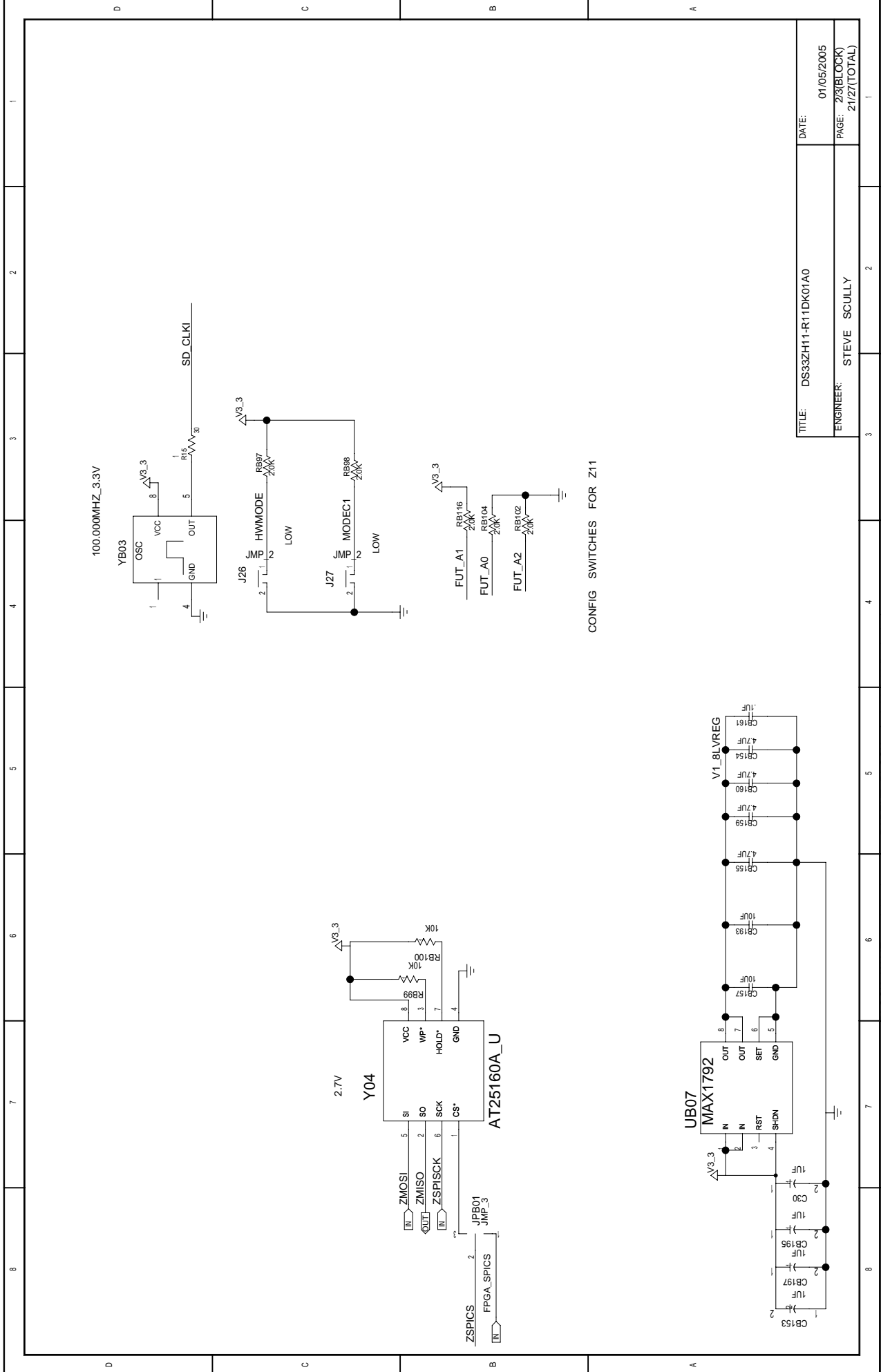

TITLE:	DS33ZH11-R11DK01A0	DATE:	01/05/2005
ENGINEER:	STEVE SCULLY	PAGE:	2/3(BLOCK)
			21/27(TOTAL)

BLOCK NAME: _zh11_dn. PARENT BLOCK: _ds33zh11dk_design

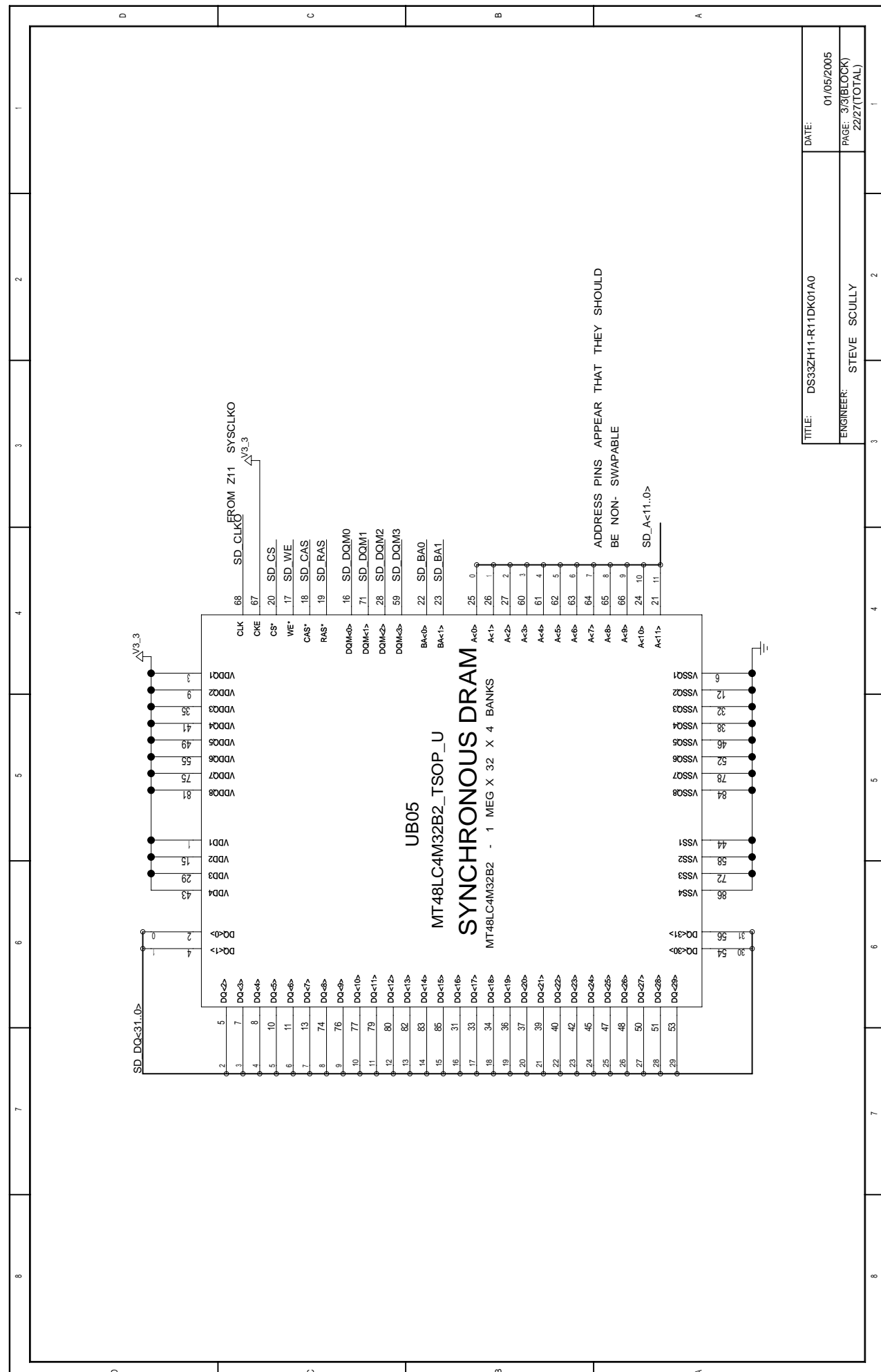

TITLE: DS33ZH11-R11DK01A0	DATE: 01/05/2005
ENGINEER: STEVE SCULLY	PAGE: 3/3(BLOCK) 22/27(TOTAL)

1	2	3	4	5	6	7	8
BLOCK NAME: _2h11_dn. PARENT BLOCK: _ds33zh11dk_design							

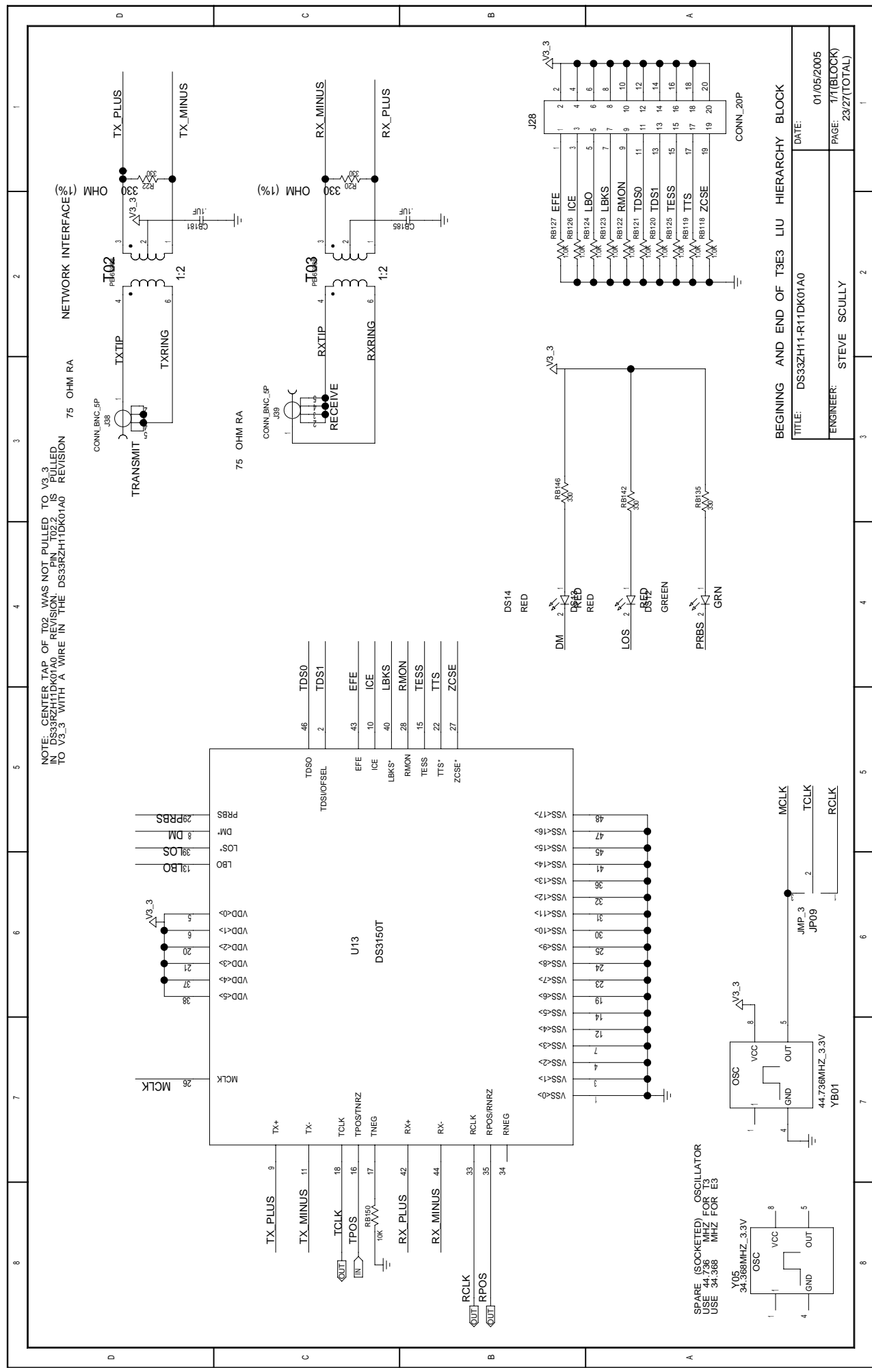

NOTE: CENTER TAP OF T05 WAS NOT PULLED TO V3_3
 DS33ZRH11-R11DK01A0 REVISION
 TO V3_3 WITH A WIRE IN THE DS33ZRH11DK01A0

75 OHM RA NETWORK INTERFACE (%)

WHO TX_PLUS TX_MINUS

75 OHM RA TX_TIP TX_RING

CONN_BNC_SP J88 TRANSMIT

OHM (%) RX_MINUS RX_PLUS

75 OHM RA RX_TIP RX_RING

CONN_BNC_SP J89 RECEIVE

46	TDS0
2	TDS1
43	EFE
10	ICE
40	LBKS
28	RMON
15	TESS
22	TTS
27	ZCSE

DS14 RED

DS15 RED

DS16 GREEN

DS17 GRN

SPARE (SOCKETED) OSCILLATOR
 USE 44.736 MHZ FOR T3
 USE 34.368 MHZ FOR E3

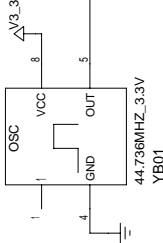
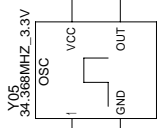

BEGINNING AND END OF T3E3 LIU HIERARCHY BLOCK

TITLE: DS33ZH11-R11DK01A0	DATE: 01/05/2005
ENGINEER: STEVE SCULLY	PAGE: 17/(BLOCK) 23/27(TOTAL)

DS21348 LIU, TRANSFORMERS AND CONNECTORS

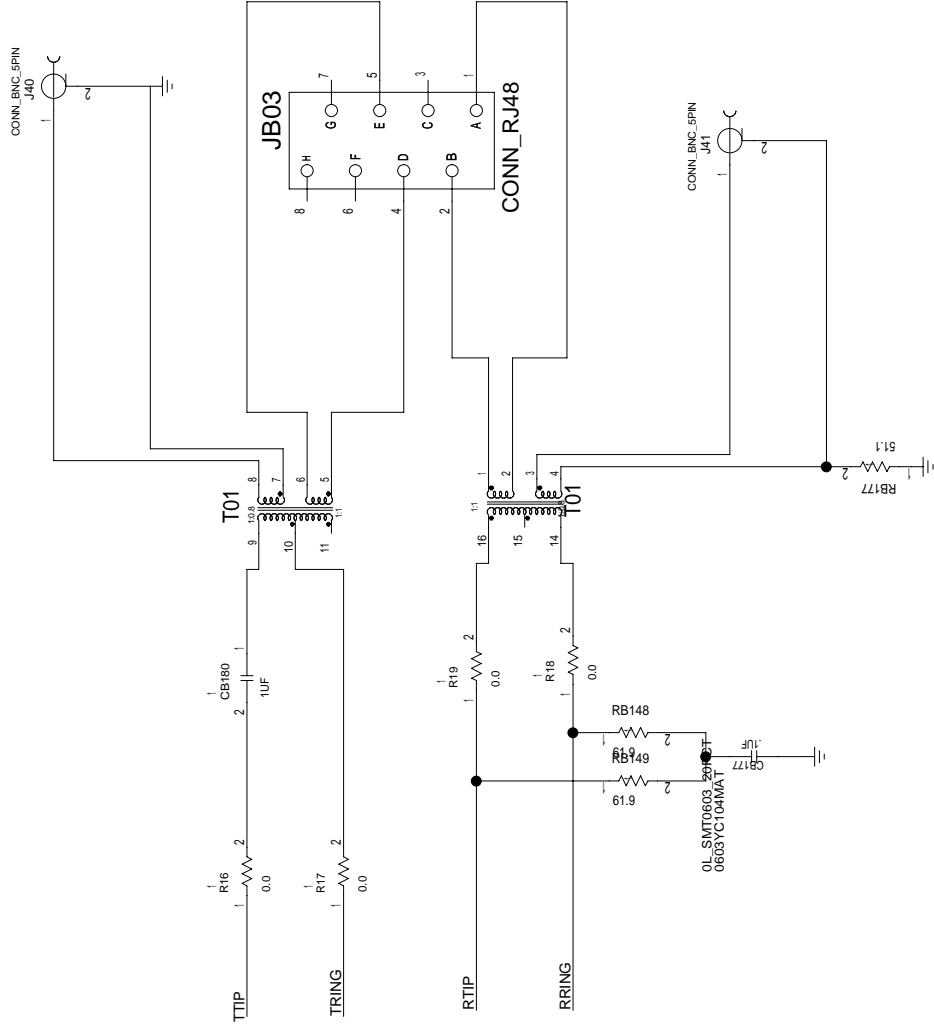

BEGINNING OF T1E1 LIU HIERARCHY BLOCK

TITLE:	DS33ZH11-R11DK01A0	DATE:	01/05/2005
ENGINEER:	STEVE SCULLY	PAGE:	1/2(BLOCK)
			24/27(TOTAL)

BLOCK NAME: _te1liu_wan_dn PARENT BLOCK: _ds33zh11dk_design

CONFIGURED FOR HW MODE

UNMARKED BIAS RESISTORS ARE 1.0K OHM

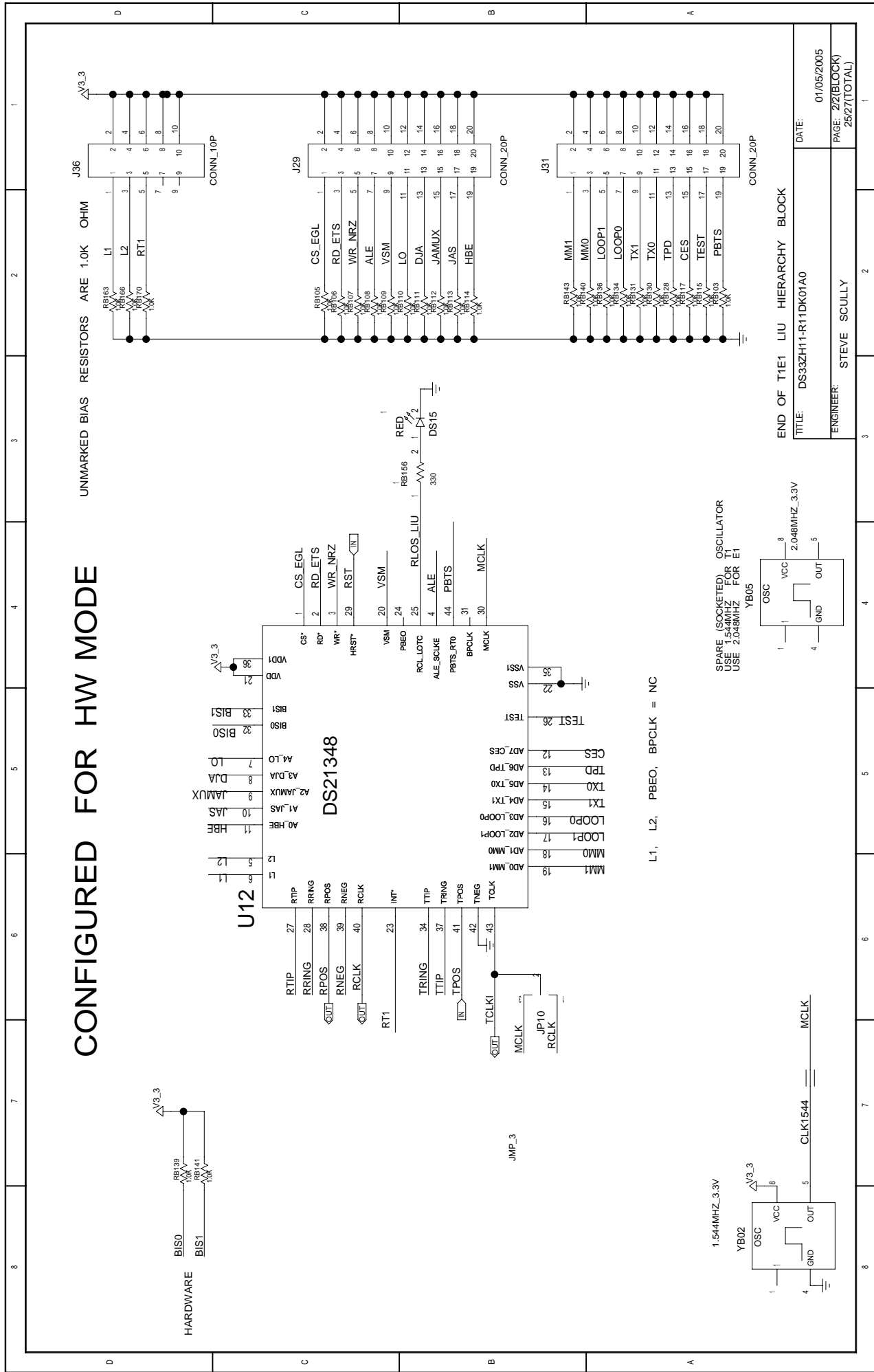

SPPARE (SOCKETED) OSCILLATOR
USE 1.544MHZ FOR T1
USE 2.048MHZ FOR E1

L1, L2, PBEO, BPCLK = NC

END OF T1E1 LIU HIERARCHY BLOCK	
TITLE: DS33ZH11-R11DK01A0	DATE: 01/05/2005
ENGINEER: STEVE SCULLY	PAGE: 22/(BLOCK) 25/27(TOTAL)

BLOCK NAME: _te1liu_wan_dn PARENT BLOCK: _ds33zh11dk_design

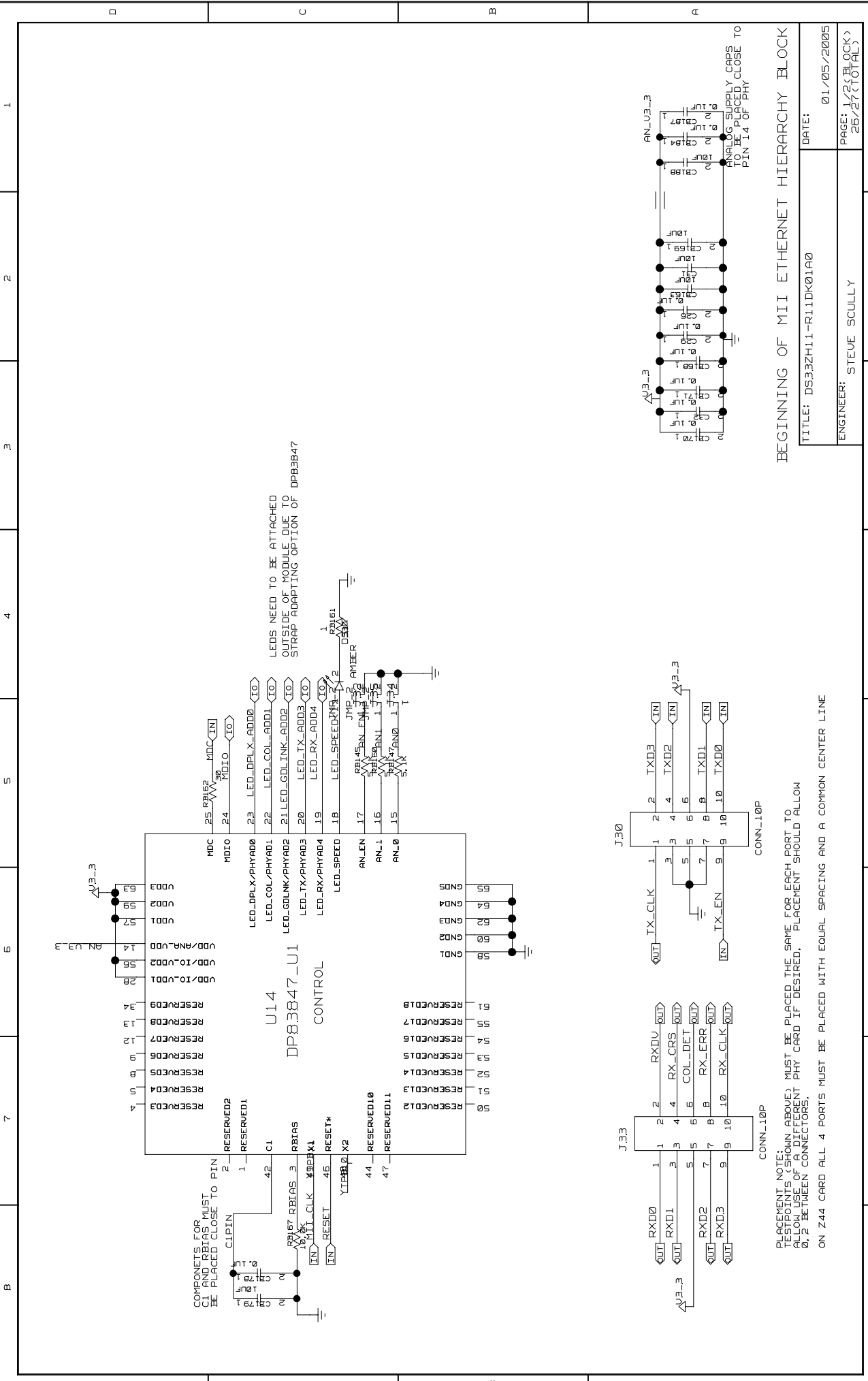

COMPONENTS FOR MDC AND MDIO MUST BE PLACED CLOSE TO PIN 1

LEDS NEED TO BE ATTACHED OUTSIDE OF MODULE DUE TO STRAP ADAPTING OPTION OF DP83847

LEDS NEED TO BE ATTACHED OUTSIDE OF MODULE DUE TO STRAP ADAPTING OPTION OF DP83847

AN-V3-3 TO BE PLACED CLOSE TO PIN 14 OF PHY

AN-V3-10 TO BE PLACED CLOSE TO PIN 14 OF PHY

DATE: 01/05/2005

ENGINEER: STEVE SCULLY

PAGE: 1/24 (BLOCK)

PAGE: 25/27 (TOTAL)

BEGINNING OF MII ETHERNET HIERARCHY BLOCK

TITLE: DS33ZH11-R11DK01A0

ENGINEER: STEVE SCULLY

DATE: 01/05/2005

PAGE: 1/24 (BLOCK)

PAGE: 25/27 (TOTAL)

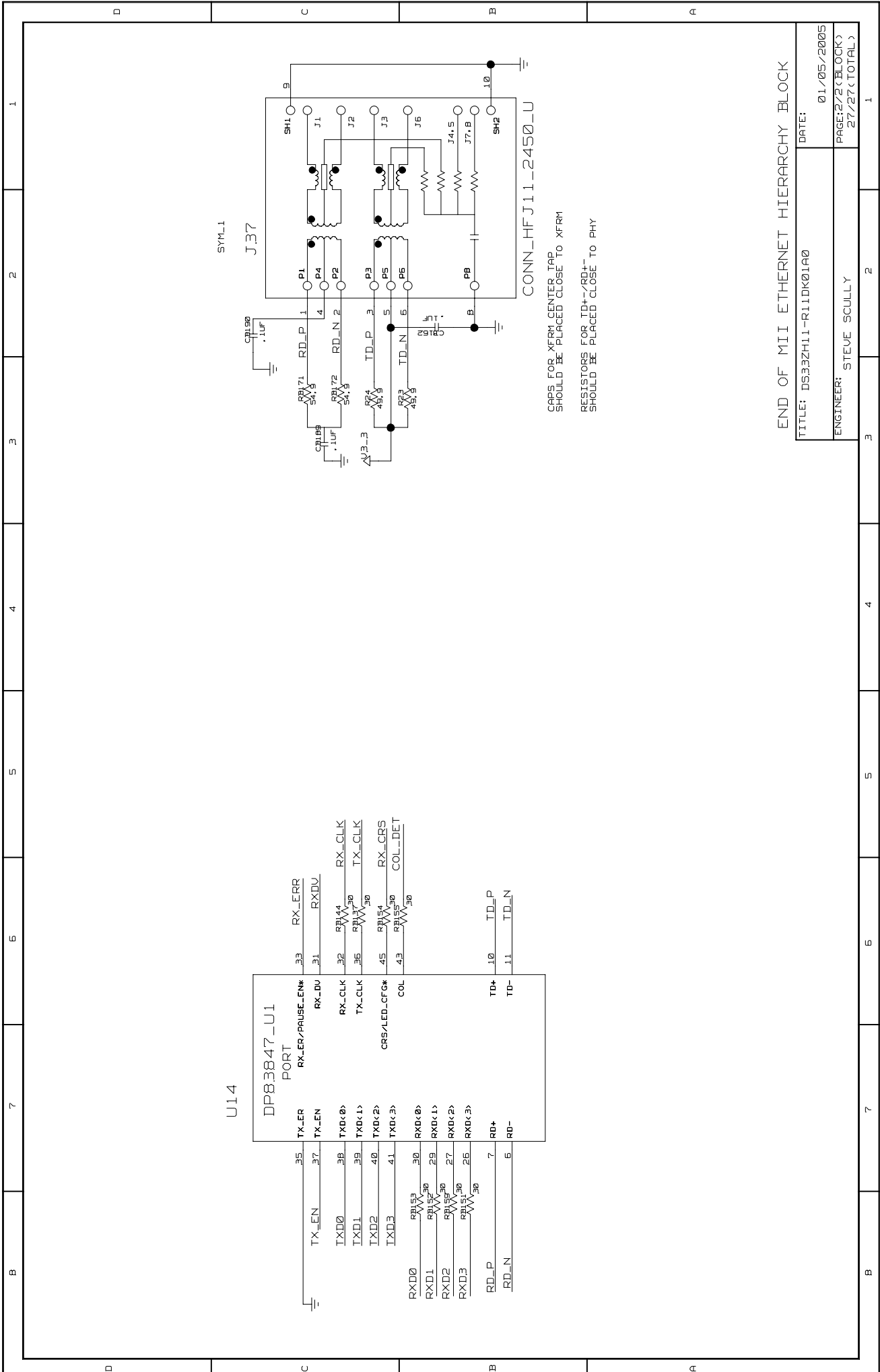

SYM_L1

J.37

CONN_HFJ11_2450_U

CAPS FOR XFRM CENTER TAP
SHOULD BE PLACED CLOSE TO XFRM

RESISTORS FOR TD+/-/RD+/-
SHOULD BE PLACED CLOSE TO PHY

U14

DP83847-U1		PORT	
TX_EN	35	RX_ER/PULSE_EN*	33
TX_EN	37	RX_DV	31
TXD0	38	RX_CLK	32
TXD1	39	TX_CLK	36
TXD2	40	CRS/LED_CFG*	45
TXD3	41	COL	43
RXD0	30	TD+	10
RXD1	29	TD-	11
RXD2	27		
RXD3	25		
RD_P	7		
RD_N	6		

END OF MII ETHERNET HIERARCHY BLOCK

TITLE: DS33ZH11-R11DK01A0	DATE: 01/05/2005
ENGINEER: STEVE SCULLY	PAGE:2/2 (BLOCK) 27/27 (TOTAL)

BLOCK NAME: _m11_wan_dn. PARENT BLOCK: _ds33zh11dk_design\